

# Marine Radio Workbook 2nd Edition

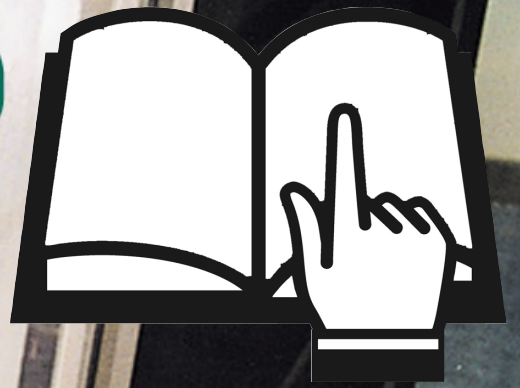

**Bob Moffatt**  
**Dave Dawson**



*Wet Paper*

# CONTENTS

---

<b>SECTION 1 INTRODUCTION .....</b>	<b>3</b>
<i>GLOSSARY OF TERMS AND ABBREVIATIONS</i>	4
<b>SECTION 2 PRINCIPLES OF RADIO TRANSMISSION .....</b>	<b>5</b>
<i>WORKSHEET 1 PRINCIPLES OF TRANSMISSION</i>	10
<b>SECTION 3 EMERGENCY POSITION INDICATING RADIO BEACONS .....</b>	<b>11</b>
<i>WORKSHEET 2 EPIRB VIDEO</i>	13
<b>SECTION 4 MARINE RADIO EQUIPMENT .....</b>	<b>14</b>
<i>WORKSHEET 3 TRANSCEIVER CONTROLS</i>	16
<b>SECTION 5 TYPES OF MARINE RADIO .....</b>	<b>17</b>
<b>SECTION 6 DIGITAL SELECTIVE CALLING (DSC) COMMUNICATIONS .....</b>	<b>19</b>
<i>WORKSHEET 4 TYPES OF CALLS</i>	21
<i>WORKSHEET 5 DIGITAL SELECTIVE CALLING</i>	22
<b>SECTION 7 MARINE RADIOTELEPHONY PROCEDURES .....</b>	<b>24</b>
<i>WORKSHEET 6 MARINE RADIO</i>	28
<i>WORKSHEET 7 TUNING A MARINE TRANSCEIVER</i>	29
<i>WORKSHEET 8 SENDING A MESSAGE</i>	30
<i>WORKSHEET 9 PHRASES AND MEANINGS</i>	31
<i>WORKSHEET 10 PHONETIC ALPHABET</i>	32
<b>SECTION 8 ALARM SIGNALS AND DISTRESS COMMUNICATIONS .....</b>	<b>33</b>
<i>WORKSHEET 11 RADIO TELEPHONE ALARM SIGNALS</i>	38
<b>SECTION 9 URGENCY, SAFETY CALLS AND SIGNALS .....</b>	<b>39</b>
<i>WORKSHEET 12 DISTRESS SIGNALS</i>	40
<i>WORKSHEET 13 MAYDAY VIDEO</i>	41
<i>WORKSHEET 14 MAYDAY</i>	42
<i>WORKSHEET 15 PAN PAN</i>	44
<i>WORKSHEET 16 SECURITE</i>	45
<i>WORKSHEET 17 FIND-A-WORD PUZZLE</i>	46
<b>SECTION 10 KEEPING YOUR RADIO WORKING .....</b>	<b>47</b>
<i>WORKSHEET 18 CONNECTING A 27MHZ TRANSCEIVER</i>	51
<i>WORKSHEET 19 INSTALLATION AND FAULTS</i>	52
<i>WORKSHEET 20 THE BATTERY</i>	53
<i>WORKSHEET 21 MAKE A REFERENCE CARD</i>	54
<b>SECTION 11 MARINE RESCUE AND PUBLIC CORRESPONDENCE .....</b>	<b>55</b>
<i>WORKSHEET 22 LOGGING OF MESSAGES</i>	59
<b>SECTION 12 REVIEW AND TESTS .....</b>	<b>60</b>
<i>WORKSHEET 23 REVIEW QUESTIONS</i>	60
<i>WORKSHEET 24 THEORY TEST</i>	62
<i>WORKSHEET 25 REVISION TEST</i>	63

© Copyright 2014

Except as permitted by the copyright law applicable to you, you may not reproduce or communicate any of the content on this website, including files downloadable from this website, without the permission of the copyright owner.

The Australian Copyright Act allows certain uses of content on the internet without the copyright owner's permission. This includes uses by educational institutions for educational purposes, and by Commonwealth and State government departments for government purposes, provided fair payment is made.

For more information, see [www.copyright.com.au](http://www.copyright.com.au) and [www.copyright.org.au](http://www.copyright.org.au).

## Published by

Wet Paper Publishers and Consultants  
A division of the Moffatt Group Australia Pty Ltd  
ACN 086 521 084  
PO Box 540  
Coolangatta 4225  
[www.wetpaper.com.au](http://www.wetpaper.com.au)



## Compiled by

Bob Moffatt and Tim Ryan

## ISBN

978-1-86283-140-7

## Honorary consultants

Dave Dawson and John Armstrong

## Original text and typesetting

Bob Moffatt

## Printed

Heaneys Printing Pty Ltd  
28 Industrial Avenue, Molendinar, Gold Coast, Qld  
1st Edition March 1999, Reprinted April 2002, Revised January 2005,  
2nd Edition October 2009

## Acknowledgements

The publisher would like to thank the following for assistance in

# SECTION 1

## INTRODUCTION

Communications at sea have come a long way in the last one hundred years. Early mariners had to rely on visual signals such as flags or sound signals such as bells and horns to communicate with others at sea. If they were too far out to sea they had no means of communication, except maybe, placing a message in a bottle and hoping it would reach its destination in time.

Modern mariners have a range of radio communication devices available to them to make their time on the water safer and more effective. The mariners use marine radios to carry out day to day tasks, deal with emergencies and in some cases, prevent an emergency occurring.

The marine radio also provides a variety of services including vital weather and navigation information, telephone calls to and from shore. (For an overview of the marine communication network see Section 11.)

All marine industries rely on the marine radio and therefore job opportunities in these industries will be enhanced if you have a proficiency in the use of these radios. Job opportunities could come in the fishing industries, tourism industry, commercial shipping and leisure industry operations.

A great way to learn how to use a radio and contribute to the community is to join a voluntary organisation.

### Operator's qualifications

Marine radios are essential safety equipment for communicating with other boats, marine rescue groups and to receive navigational warnings and weather updates

#### Licences and certificates

All crew should be competent in the operation of the marine radios onboard, know the frequencies dedicated to distress and safety and be able to properly format and transmit distress and safety messages.

All crew should be competent in the operation of the marine radios onboard, know the frequencies dedicated to distress and safety and be able to properly format and transmit distress and safety messages.

Under federal regulations, operators of VHF and HF radios are required to hold an operating certificate; the normal certificate for recreational operators is the Marine Radio Operators Certificate of Proficiency (MROCP).

Many Coast Guard and Volunteer Marine Rescue stations provide this course or may advise where a local course is available.

Operators of 27 MHz equipment are not required to hold a certificate but are strongly recommended to obtain one. Information about licensing of radios and operators, can be found at the Australian Communications and Media Authority website at

<http://www.acma.gov.au>.



Figure 3.1 In this course you will learn to use a marine radio to send and receive messages at sea

### Marine Radio operator's handbook

The Office of Maritime Communications at the Australian Maritime College produces the 'Marine Radio operator's handbook', which is a 128 page handbook intended as a guide for operators of marine radio equipment..

The 2008 edition had a cost of about \$34 and is available from:

Office of Maritime Communications  
Australian Maritime College  
PO Box 986  
Launceston Tasmania 7250

#### Download the handbook

The OMC also has a web site where the handbook can be found and down loaded (read only) using the adobe acrobat reader program.

Use the following web site to do this:  
<http://amcom.amc.edu.au>



## Glossary of terms and abbreviations

ACA	Australian Communications Authority
AM	Amplitude modulation
AMSA	Australian Maritime Safety Authority
AUSREP	Australian Ship Reporting System
AusSAR	The operating authority for RCC Australia
Ch	Radio channel
Coast station	A land station in the maritime mobile service providing terrestrial communications to and from ships at sea
COSPAS-SARSAT system	A satellite-aided search and rescue system based on low-altitude near polar orbiting satellites and designed to locate emergency position indicating radio beacons transmitting on the frequencies of 121.5 and 406.025 MHz
CQ	General call to all stations. Frequently used in Morse code transmissions. May also be used in radiotelephony.
DSC	Digital Selective Calling - a digitised alerting technique used between stations in the marine service.
ELB	Emergency locating beacon
EPIRB	Emergency position indicating radio beacon
Geostationary satellite	A satellite whose period of revolution is equal to the period of rotation of the Earth and whose circular and direct orbit lies in the plane of the equator - that is a satellite which remains approximately fixed relative to a position on Earth.
GHz	Gigahertz (1 000 000 000 hertz). A measurement unit of radio frequency
GPS	Global Positioning System. A satellite-based system for calculating positions anywhere on the Earth's surface.
GMDSS	Global Maritime Distress and Safety System
HEX ID	See UIN
HF	High Frequency (3 to 30 MHz)
Hz	Hertz. A measurement unit of radio frequency.
Inmarsat	International Maritime Satellite Organisation
kHz	Kilohertz (1000 hertz). A measurement unit of radio frequency.
kW	Kilowatt (1000 watts). A measurement unit of radio power.
LCS	Limited coast station
LES	Land Earth station
LUT	Local User Terminal - a ground receiving station which receives data from COSPAS and SARSAT satellites, calculates the position of the beacon and forwards the resultant information to search and rescue authorities.
MMSI	Maritime Mobile Service Identity - A unique nine digit group required as electronic identification by stations using digital selective calling techniques
MHz	Megahertz (1 000 000 hertz). A measurement unit of radio frequency.
MF	Medium frequency (300 to 3000 kHz)
MROCP	Marine Radio Operator's Certificate of Proficiency
MROVCP	Marine Radio VHF Operator's Certificate of Proficiency
Nm	Nautical mile/s (1.85 km)
OMC	Office of Marine Communications
RCC	Rescue Coordination Centre located in Canberra, and operated by AusSAR
RROCP	Restricted Radiotelephone Operator's Certificate of Proficiency
SAR	Search and rescue
SSB	Single sideband
Single frequency	The same frequency used for transmission and reception
Telstra	Telstra mobile satellite and radio services
UIN	The Unique Identity Number (UIN or HexID) is the unique code programmed into each 406 MHz distress beacon and transmitted when the beacon is activated
VHF	Very high frequency (30 to 300 MHz)

# SECTION 2 PRINCIPLES OF RADIO TRANSMISSION

The marine radio is a source of information for many and a job for others. In an emergency at sea, a radio is a vital link for being rescued or obtaining assistance — for some it may be the difference between life and death.

In this introductory course, we want to outline to you the various aspects of radio communication which will make you more confident in using common marine radios.

## Principles of radio transmission

In 1888 Heinrich Hertz designed an experiment to see if he could send a message through thin air.

Hertz demonstrated that if the sub atomic particles in the generator called electrons could be made to accelerate rapidly, radio waves would be made. In his first experiments these electrons were accelerated to 50,000,000 cycles per second. This was known as the frequency of the transmitter.

In honour of Hertz scientists named the unit of **frequency** after him instead of using "cycles per second", and we now abbreviate the frequency as Hz.

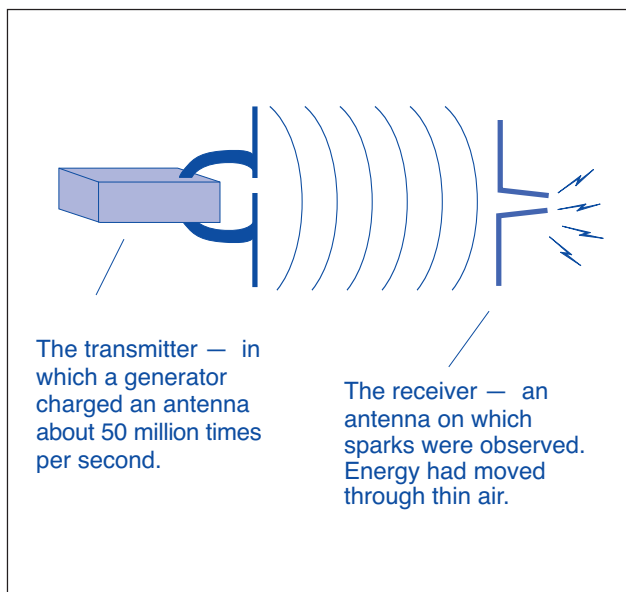

Figure 5.1 The Hertz experiment

We now know that it is possible to generate radio waves of many different frequencies over the radio spectrum.

One megahertz (MHz) is a higher frequency than one kilohertz, which in turn is a higher frequency than one hertz.

The different frequencies and their abbreviated terms are shown in Figure 5.2.

1 kilohertz = 1000 Hertz  
 1 Megahertz = 1000 kilohertz

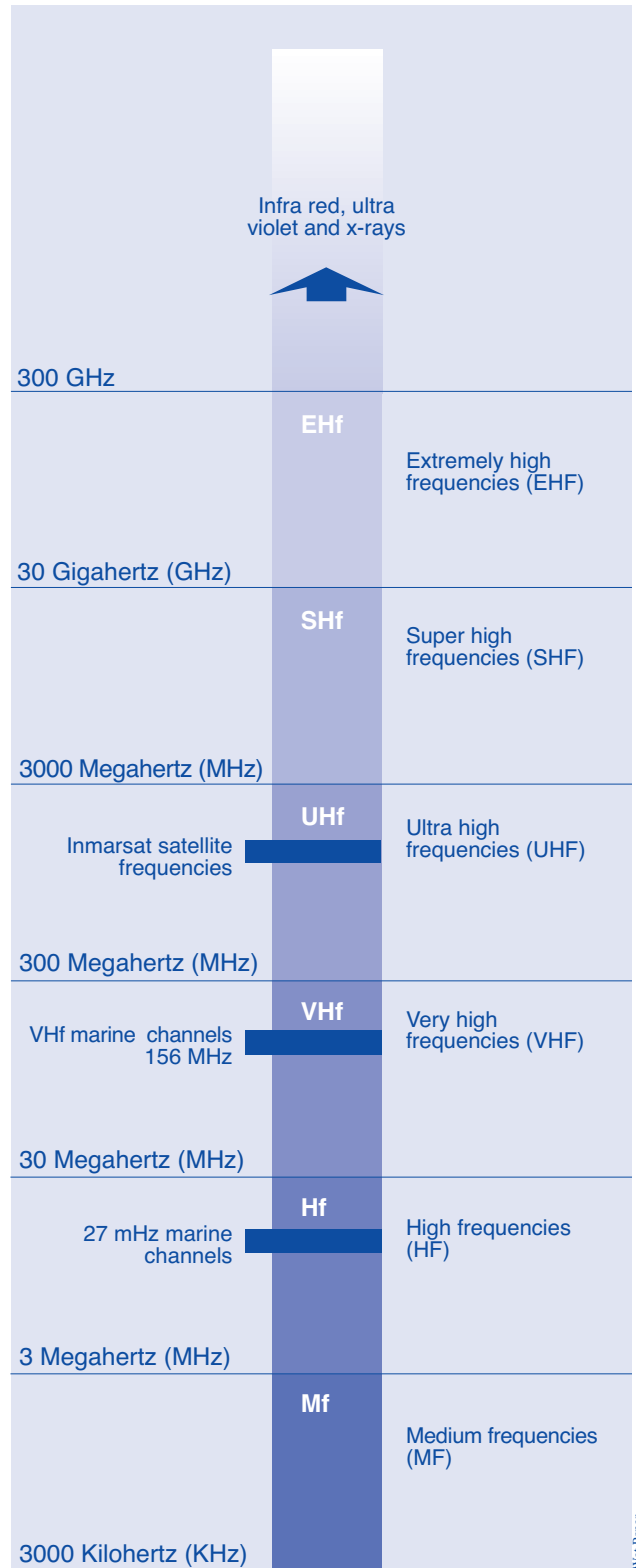

Figure 5.2 Part of the radio spectrum

## Line of sight transmission

When a radio wave is sent from a base station on land, the wave travels through the air and is absorbed by the antenna of a receiver on the vessel at sea. Here it produces a small current which can be converted into voice signals and reproduced in a loud speaker.

Figure 6.1 summarises this process.

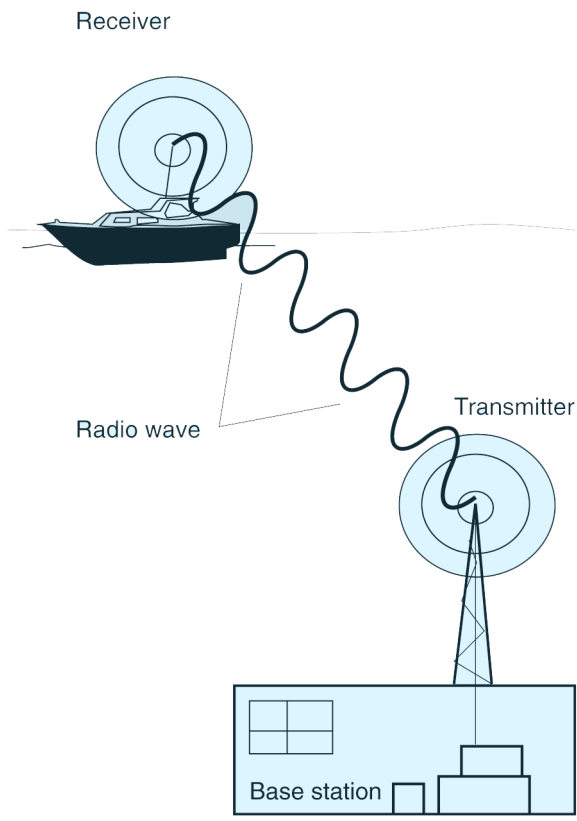

Figure 6.1 Principles of radio transmission

A **radio wave** is like a wave in the ocean. It has a top (the crest) and bottom (the trough) a height called the amplitude and a length as shown in Figure 6.2.

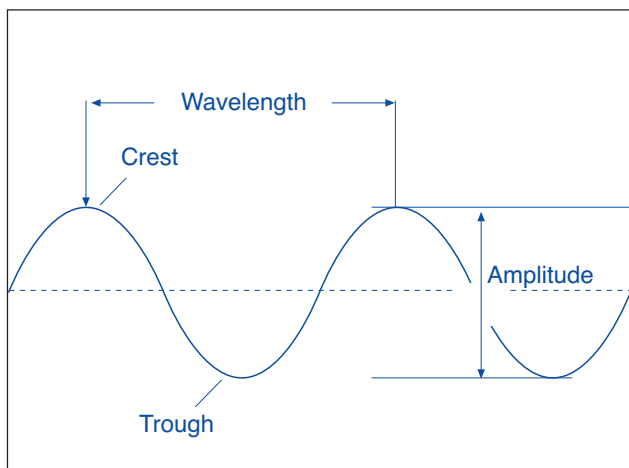

Figure 6.2 Wave characteristics

A radio wave is usually called a **carrier wave** (Figure 6.3) since it carries the information to produce the sound for the radio. You could turn the radio transmitter on and off in accordance with a recognised code, such as Morse code, and be able to convey information from the transmitter to a receiver. Today radiotelephony has replaced Morse code which is now seldom used.

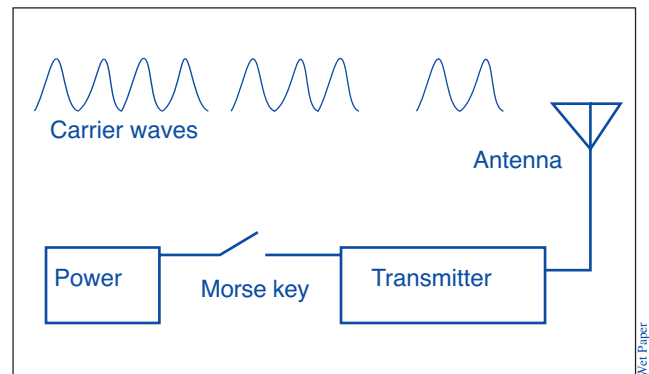

Figure 6.3 A diagram to show interrupted carrier waves

Because Morse code is difficult to learn, information exchange by radio between small vessels is usually conducted by radiotelephony (voice signals by radio). To be able to transmit voice signals by radio it is necessary to alter the carrier wave in synchronisation with the speech information to be transmitted. This is known as **modulation**.

Carrier waves may be modulated to carry speech information by altering the size (amplitude) of the wave. This is known as **amplitude modulation (AM)**.

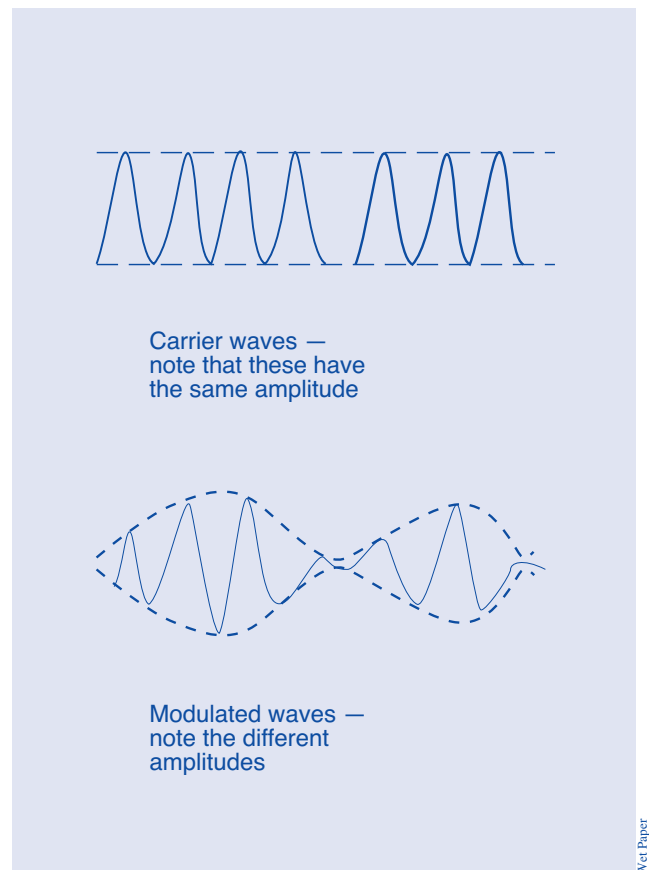

Figure 6.4 A block diagram of an AM speech transmission

Carrier waves may also be modulated by small alternations of their frequency (cycles per second or hertz). This is known as **frequency modulation (Figure 7.1)**.

Both forms of modulation are used in marine radio communication.

Some marine radio equipment is also capable of a slightly different form of amplitude modulation known as single sideband (SSB). It is sufficient to understand that use of single sideband allows both the transmitter and the receiver to operate in a more efficient manner and will often improve the chances of successful communications under poor conditions or at extremes of range.

## How radio energy travels through space

The theory of propagation, or how radio energy travels through space, is a complex and difficult subject. However, to appreciate and understand the capabilities and limitations of your marine radio transceiver, a basic understanding is necessary.

When the radio frequency energy is radiated from the antenna of marine radio equipment it can travel through space in two differing ways — ground waves and sky waves.

### Sky waves

**Sky wave** energy travels upwards at a wide range of angles until it meets the **ionosphere**, which is that part of the earth's atmosphere that lies between 80 and 350 kilometres above the earth's surface.

As the radio frequency energy meets these ionised layers, some of it is bent or reflected back to the earth's surface. Sky waves travel much further than ground waves before they lose their energy and make it possible to communicate over very long distances.

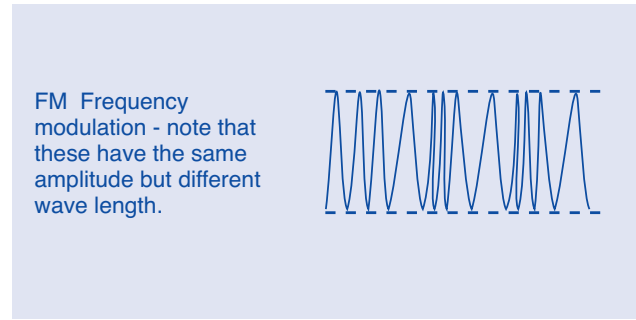

Figure 7.1 FM modulation

### Example of a radio message

Example of a radio check made to test reception. You will learn how to do this in Section 7.

- *Redcliffe Coast Guard, Redcliffe Coast Guard, Redcliffe Coast Guard, this is Reef Seeker, Reef Seeker (OVER)*
- *Reef Seeker this is Redcliffe Coast Guard please switch to Channel 73.*
- *Redcliffe Coast Guard, this is Reef Seeker, Reef Seeker, Reef Seeker, am going out boating today and wanting a radio check (OVER)*
- *Reef Seeker this is Redcliffe Coast Guard your signal strength is FOWER to FIFE (OVER)*
- *Redcliffe Coast Guard, this is Reef Seeker Reef Seeker, thank you (OUT)*
- *Reef Seeker this is Redcliffe Coast Guard (OUT)*

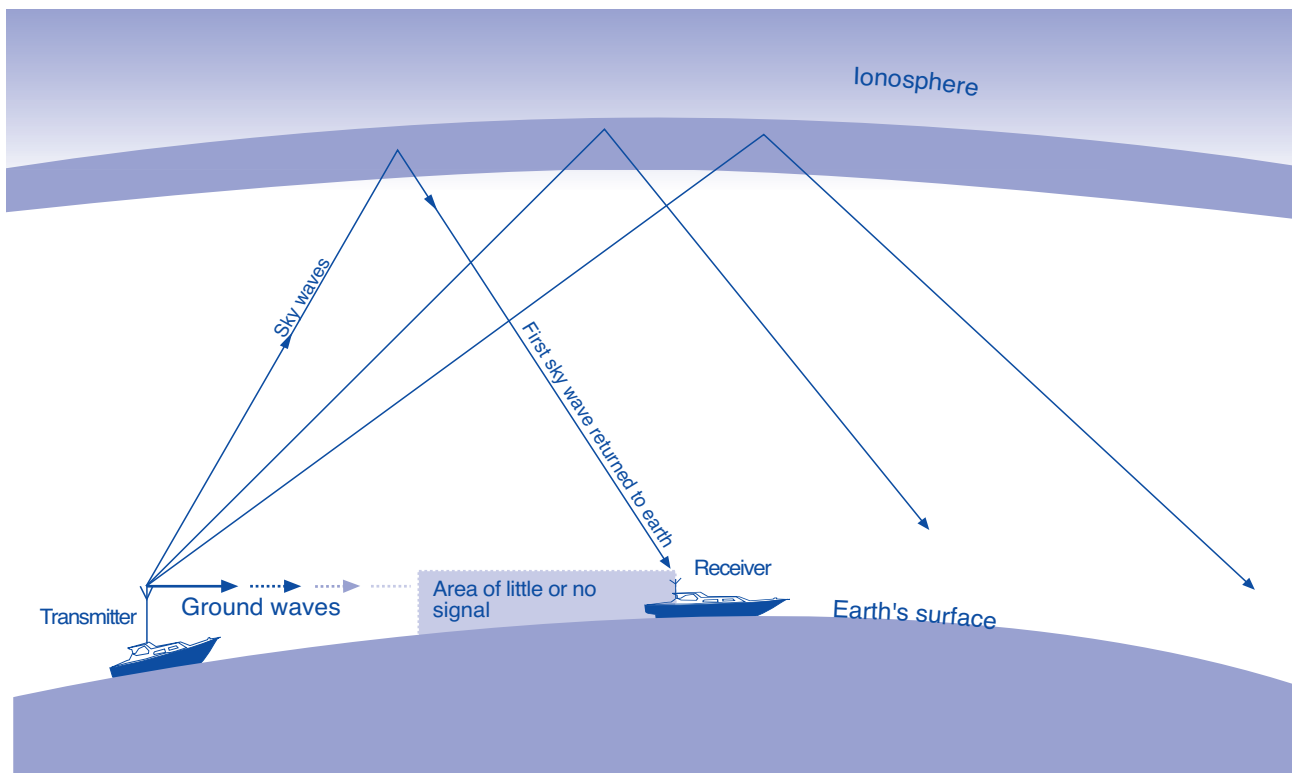

Figure 7.2 Propagation of sky waves

There are many variables which affect sky wave propagation. The time of the day or night, the seasons and sunspot activity all substantially affect the way the sky wave energy will behave. Consequently, we need to have available different channels or frequencies to suit the differing conditions and the range of communications desired. Reliable use can be made of both the ground and sky wave energy components permitting communications both at short range and over many thousands of kilometres.

### Ground waves

**Ground waves** travel over the Earth's surface from the transmitter to the receiver.

They use up their energy quickly, particularly when travelling over large land masses, and are therefore effective for short range communications only.

Ground waves can be blocked by islands or headlands as shown by Figure 8.1

## Propagation at MF and HF

At medium and high frequencies, reliable use can be made of ground and sky wave energy components, allowing communications over short and long ranges. MF/HF marine radio equipment will always offer the operator a selection of frequencies in different bands.

For example 2182 kHz in the 2 MHz band, 4125 kHz in the 4 MHz band, 6215 kHz in the 6 MHz band etc.

This allows the operator to select a frequency which will be suitable both for the distance over which communications are required, and the time of day and season.

One rule for frequency selection is to use the lower frequencies when close to the required station and the higher frequencies when further away.

At night, a frequency lower than that necessary during the day is more likely to be effective.

Islands or headlands block line of sight transmissions from ground waves

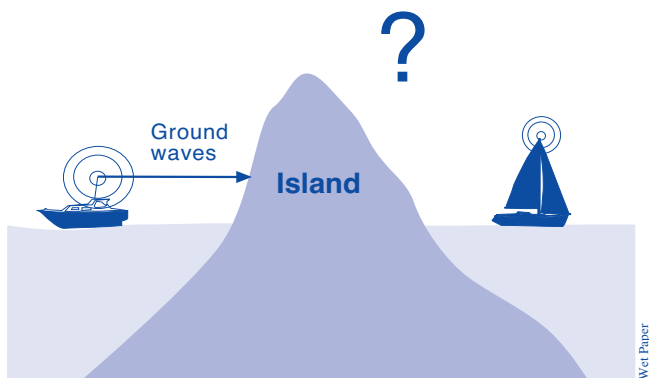

Figure 8.1 Ground waves can be affected by islands

The Australian Communications Authority recommends as a very approximate guide, the use of 2 MHz band frequencies for communicating with stations within 100 km (55 nautical miles) day or night.

## Propagation at 27 MHz

For the majority of time, the 27 MHz sky wave is not reflected back to earth. Only ground wave communications are possible resulting in similar ranges to VHF.

However under certain atmospheric conditions the ionosphere will bend back the 27 MHz sky wave permitting communications over hundreds or thousands of kilometres (popularly referred to as 'skip').

However ground wave communications form the only reliable method of communicating frequency.

## Propagation at VHF

There is no reflection of VHF radio energy from the ionosphere. Consequently, VHF communications is by ground wave only and is effective for short ranges only. As a general rule, VHF communications are 'radio line of sight' which is slightly further than visual 'line of sight'.

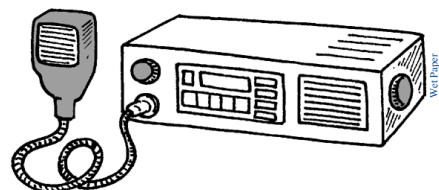



## Teacher demonstration – let's look at sound

### Aim

To use a cathode ray oscilloscope (CRO) to investigate the radio waves

### Apparatus

- small microphone
- audio amplifier
- audio oscillator
- power supply
- flute or other similar musical instrument
- cathode ray oscilloscope (CRO)
- Note: Most Science departments will have a cathode ray oscilloscope. The cathode ray oscilloscope will show the wave patterns produced by the electrical signals coming from the microphone.



Figure 9.1 Ask your Physics teacher to help you set this up

### Method

1. Set up the cathode ray oscilloscope according to the instructions supplied by the manufacturer.
2. When a fine continuous trace is seen on the screen set the V/cm knob to 0.5 and the T/cm knob to 1ms.
3. Switch on the audio oscillator and the audio amplifier.
4. Set the audio oscillator on its lowest frequency and slowly increase the frequency. Observe the wave patterns. What happens to the number of waves seen on the screen as the frequency increases? Record the lowest frequency detected by the students in your class. Record the highest frequency detected by members of the class. Could the students detect a greater range of frequencies than the teacher?
5. Increase the loudness of the sound using the audio amplifier. How do the wave patterns change?
6. Use a flute or similar musical instrument to play a note into the microphone. Notice the wave pattern produced on the screen.
7. Have a student recite a nursery rhyme into the microphone. Notice the shape of the waves produced.

### Questions

1. What frequencies can the human ear detect?  
\_\_\_\_\_
2. How can forensic science identify a suspect by their voice?  
\_\_\_\_\_  
\_\_\_\_\_  
\_\_\_\_\_
3. Discuss the wave pattern of sound on the cathode ray oscilloscope.  
\_\_\_\_\_  
\_\_\_\_\_  
\_\_\_\_\_  
\_\_\_\_\_  
\_\_\_\_\_  
\_\_\_\_\_  
\_\_\_\_\_  
\_\_\_\_\_  
\_\_\_\_\_  
\_\_\_\_\_

# WORKSHEET 1 PRINCIPLES OF TRANSMISSION

All illustrations this page drawn by Wet Paper

## Answer the following questions

1. Describe the principles of radio transmission as discovered by Hertz in 1888.

---

---

---

2. What is a carrier wave?

---

3. Write the names of the parts of a radio wave identified a – c in the diagram of the radio wave below

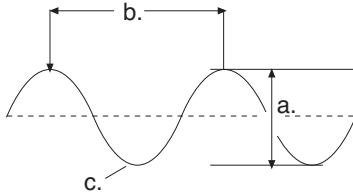

- a. \_\_\_\_\_
- b. \_\_\_\_\_
- c. \_\_\_\_\_

4. Define the following terms:

a. modulation

b. skip

c. radiotelephony

---

---

---

5. Outline the 'theory of propagation'.

---

---

6. Name the type of modulation shown below.



Modulation A

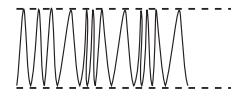

Modulation B

---

7. Explain why 'sky waves' travel further than 'ground waves'.

---

---

8. How might 'skip' be a problem when using a marine radio?

---

---

---

---

---

---

# SECTION 3 EMERGENCY POSITION INDICATING RADIO BEACONS

A distress beacon is a small electronic device that, when activated in a life-threatening situation, assists rescue authorities in their search to locate those in distress.

In Australia, three types operate on the 406MHz frequency:

- Emergency Position Indicating Radio Beacons (EPIRB) used in ships and boats;
- Emergency Locator Transmitters (ELT) used in aircraft;
- Personal Locator Beacons (PLB) for personal use by bushwalkers, four-wheel drivers, other adventurers on land, employees working in remote areas, crew in boats and aircrew.

## Emergency Position Indicating Radio Beacons (EPIRB)

EPIRBs are designed to float in the water to optimise the signal to the satellite. An EPIRB is required to operate for a minimum of 48 hours continuously once activated. An EPIRB has a lanyard that is used to secure it to something that is not going to sink so that it can float free.

Float-free EPIRBs are held in a bracket and fitted with a hydrostatic release that is water activated deploying the beacon automatically if the vessel sinks. If the vessel continues to float then the EPIRB can be manually deployed where a distress situation exists.

406 MHz beacons come in two basic types: those that provide an encoded (GPS) location and those that do not. The satellite system can calculate a beacon's location, but locating a distress site is usually much faster if the beacon signal provides a GPS location.

### What is the HexID or UIN?

The HexID or Unique Identity Number (UIN) is the unique code programmed into each 406 MHz distress beacon and transmitted when the beacon is activated.

When registering a distress beacon, this code must be included on the registration form as it is the only code that links the individual distress beacon to the registration database. Without the HexID the beacon cannot be registered. For the latest information on EPIRB coding and decoding see: [http://beacons.amsa.gov.au/distress\\_beacons.asp](http://beacons.amsa.gov.au/distress_beacons.asp)

### Old EPIRBs

In February 2009 the 121.5 MHz system was turned off. Do not dispose of old EPIRBs in the garbage bin. Check with the web site above for the correct method of disposal.



Figure 11.1 An Emergency - Position - Indicating - Radio - Beacon

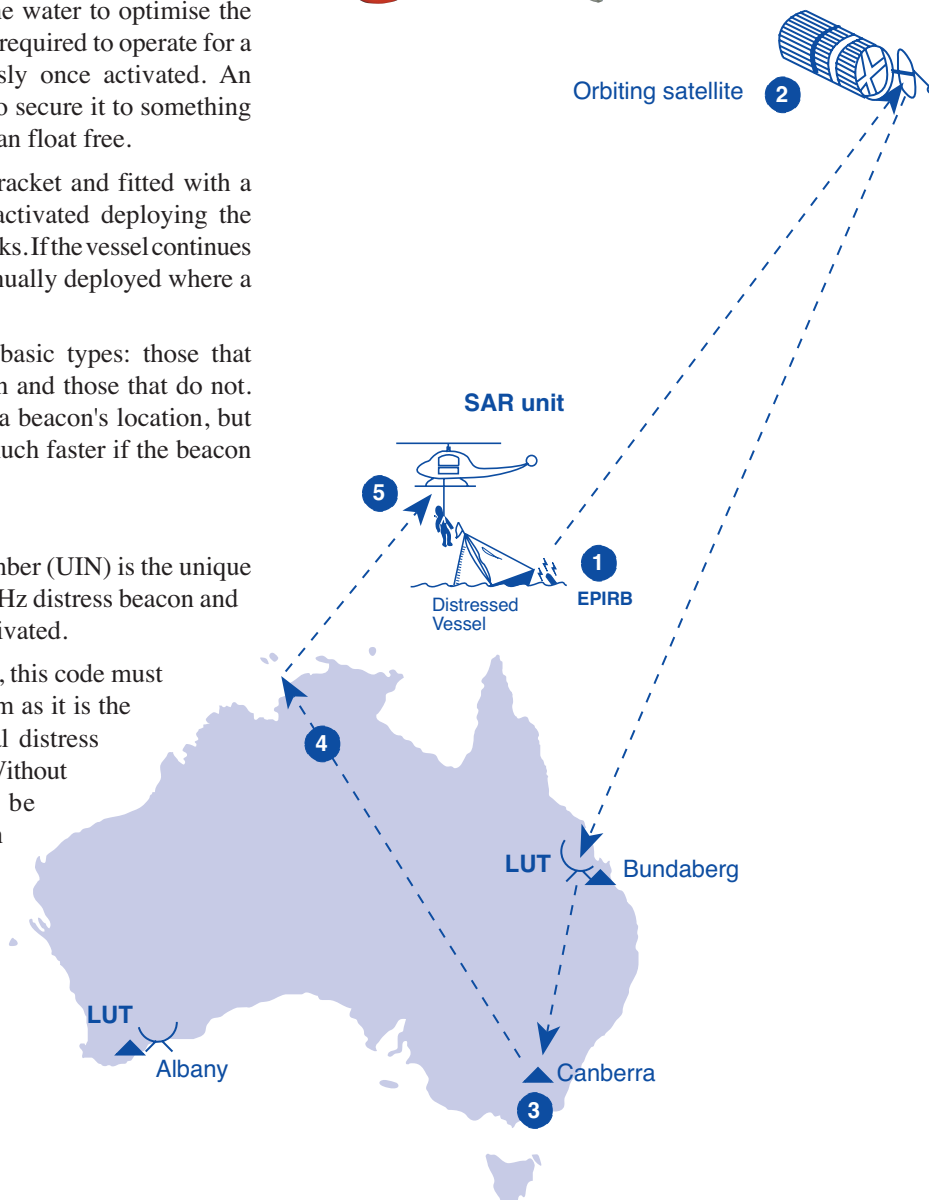

Figure 11.2 Rescue sequence involving an EPIRB. (Note: SAR - Search and rescue, LUT - Local user terminal)

Should an owner discover that an EPIRB has been accidentally activated, information must be passed immediately to the following number: 1 800 641792. If you are at sea the information should be immediately passed on to a coast station or a marine rescue organisation which will relay this message to the Rescue Coordination Centre in Canberra. Search and rescue authorities will not penalise an EPIRB owner or operator in cases of genuine accidental operation.

### EPIRB fact file

The old 121.5 MHz signal was analog and was not stored aboard the satellite giving an average notification time of 6 hours.

The 406 MHz signal is digital and can be stored aboard the satellite for later relay to the next available ground station, thereby giving it global capability and a 1-hour average notification time.

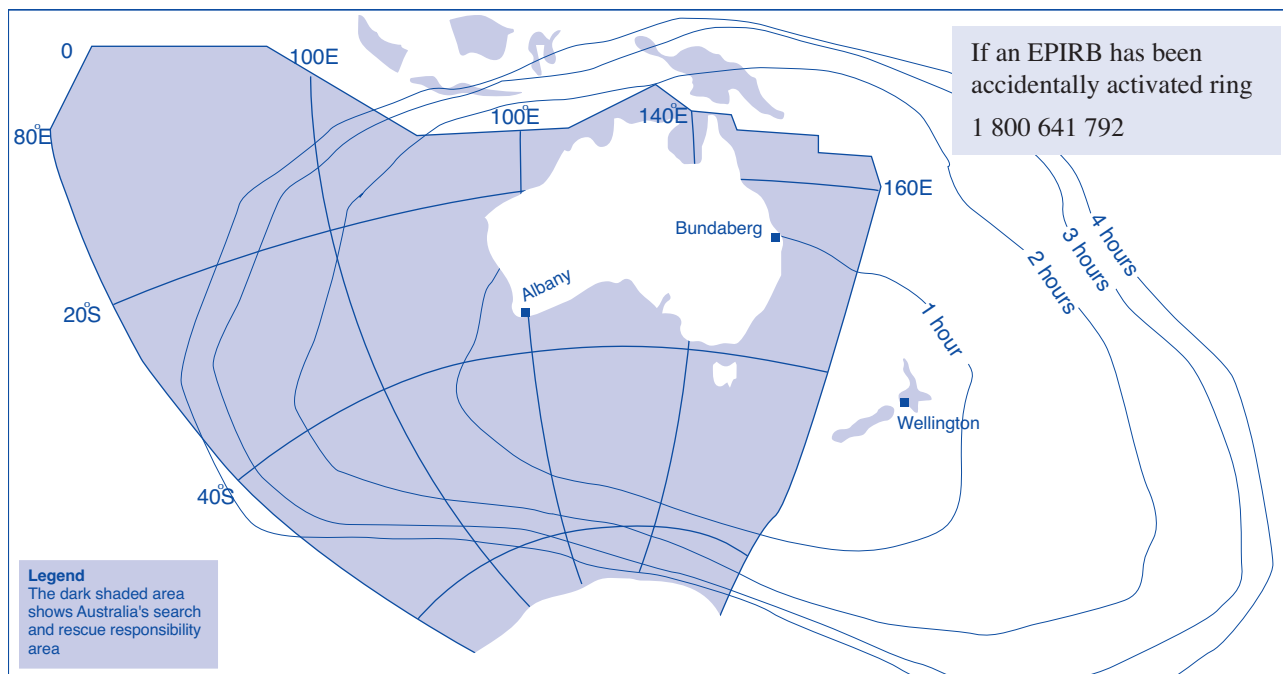

Figure 12.1 COSPAS-SARSAT system coverage for 121.5 / 243 MHz EPIRBs using local user terminals located in Queensland, Western Australia and New Zealand. Median time to detect and locate an activated beacon is also shown.

# Saved by simple investment

By Dennis Watt

Lone English sailor Don Ling congratulated himself on “the best 400 quid I ever spent” when a rescue helicopter picked him from wild seas off Fraser Island yesterday.

During his ordeal 40km north-east of Sandy Cape, the shipwrecked former civil servant clutched a radio beacon which transmitted distress signals via satellite to Canberra.

Seven hours after his 12.5m catamaran sank following a collision with a bulk ore carrier, the signals led a Bureau of Emergency Service helicopter from Brisbane straight to Mr Ling.

The helicopter, after being alerted by the Marine Rescue Co-ordination Centre, was unable to leave Brisbane until 4 a.m. because of poor weather.

Clad only in his life jacket, waterproof coat, T-shirt and cotton shorts, Mr Ling, 59, battled cold, 3 m seas, driving rain and 35 knot winds.

Huge waves pummelled him throughout the night, leaving his lean frame with a mass of bruises.

The life saving EPIRB – emergency position indicating radio beacon – had cost Mr Ling

four hundred pounds (\$1000 AUS) when he left England on his world sailing odyssey four years ago.

They now cost about \$200.

A battered Mr Ling, speaking from his bed at the Maryborough Hospital where he is under observation, said: “When I bought the beacon, I thought it was a lot of money.

Now I reckon it’s the best money I’ve ever spent in my life. Only a fool would go to sea without one.”

Mr Ling said his boat sank about midnight, six hours after the collision with the freighter which stopped to provide assistance and offered to take him aboard.

But Mr Ling was confident *The Blue Goose of Arne* was seaworthy enough to continue his return trip from New Zealand to Gladstone.

Thirty minutes after the freighter departed, one of the hulls split and the boat began to sink.

Mr Ling told of his relief in seeing “a blue dot on the horizon” soon after 7 a.m.

Helicopter pilot Rob Rich and crewman Daren

Parsons and Mal Aitken saw Mr Ling when they passed over him for the third time.

“On the third time they came around, I came out on top of a wave and they saw me waving,” he said.

Mr Ling described all those involved in his rescue and hospital care as “angels of mercy.”

All his possessions, other than the clothes he wore and a suitcase of clothes in England, were lost when the yacht sank.

The sailing grandfather’s greatest regret was the loss of notes and photos recording his trip.

“But I’ve got my life and I’ve got some very good friends around the world,” he said.

At times he was frightened when swamped by “waves of white water but I wasn’t worried.”

Mr Ling said he tried to conserve heat and energy during the night by pulling his body into a ‘Z’ shape.

When dawn broke, he “did a few exercises and started swimming around.”

As soon as he gets a chance, Mr Ling will be back at sea again, probably as a crewman.

“I’m happy at sea,” he said.

Figure 12.2 Article courtesy Gold Coast Bulletin

# WORKSHEET 2 EPIRB

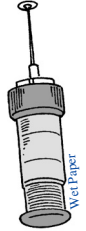

1. What does the term EPIRB stand for?  
\_\_\_\_\_
2. What happens when it is activated and what frequency does it transmit on?  
\_\_\_\_\_
3. How far away can the signals be transmitted?  
\_\_\_\_\_
4. What number should you ring if an EPIRB is inadvertently switched on?  
\_\_\_\_\_
5. What are the responsibilities of the Rescue Co-ordination Centre?  
\_\_\_\_\_  
\_\_\_\_\_
6. Where are Australia's local user terminals located?  
\_\_\_\_\_  
\_\_\_\_\_
7. Look at Figure 11.2 on page 11 and answer the following questions.
  - a. Forecast the result of an activated EPIRB off the Queensland coast .  
\_\_\_\_\_  
\_\_\_\_\_  
\_\_\_\_\_
  - b. What do the terms SAR, LUT and RCC, stand for?  
\_\_\_\_\_  
\_\_\_\_\_  
\_\_\_\_\_

## Research questions

1. What development has made EPIRBs more effective as distress signals?  
\_\_\_\_\_
2. Which beacon is recommended for boats operating beyond 900 km offshore?  
\_\_\_\_\_
3. What is the fundamental difference between EPIRB and Marine Radio transmissions?  
\_\_\_\_\_
4. Complete these sentence: 121.5 MHz Beacon: Time to relay signal accurately \_\_\_\_\_ 406 MHz Beacon: Time to relay signal accurately \_\_\_\_\_ (see fact file page 12)
5. Read the article on the page opposite about the adventures of Don Ling. Now use the arguments presented in the article to write two sentences on the importance of carrying an EPIRB.  
\_\_\_\_\_  
\_\_\_\_\_  
\_\_\_\_\_  
\_\_\_\_\_  
\_\_\_\_\_

# SECTION 4 MARINE RADIO EQUIPMENT

The marine radio system is made up of three major parts:

- the antenna
- the transmitter and receiver and
- the power supply.

## What the transmitter and receiver do

The function of the **transmitter** is to turn our voice signals spoken into the **microphone** into a form that can travel through space over very long distances. It does this by producing radio carrier waves. These carrier waves are then modulated with our speech signals, increased in strength (amplified) and passed to the **antenna** for radiation into space.

The function of the **receiver** is to select from all the radio carrier waves received from the antenna only those we require. These radio carrier waves are then de-modulated which is simply the process to recover the voice information which they are carrying. The voice signals are amplified and passed to the **loud speaker**. It is normal with the marine radio systems for the transmitter and receiver to be combined in a single unit called a **transceiver**.

## What an antenna does

During transmissions, radio frequency energy is radiated from the antenna. During reception it is the device that gathers the radio energy from space and passes this information to the receiver. Therefore, the antenna will be connected to either the transmitter or the receiver depending on whether transmission or reception is taking place. The change-over is effected by the press-to-talk button on the microphone.

## What the power supply does

The task of the power supply is to supply electrical energy to the transmitter and receiver to enable them to perform their functions. Batteries provide the most convenient form of power supply in small craft.

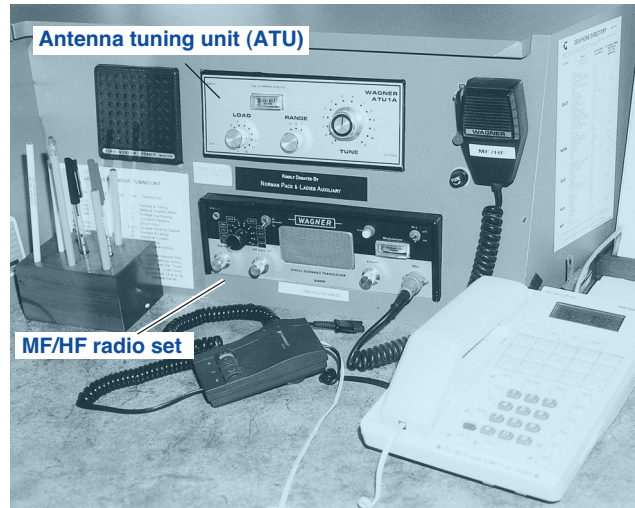

Figure 14.1 MF/HF radio set with antenna tuning unit (ATU) mounted above

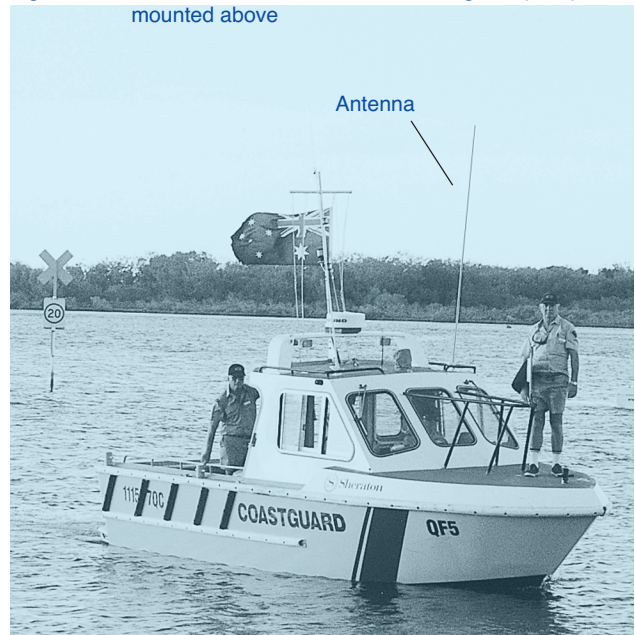
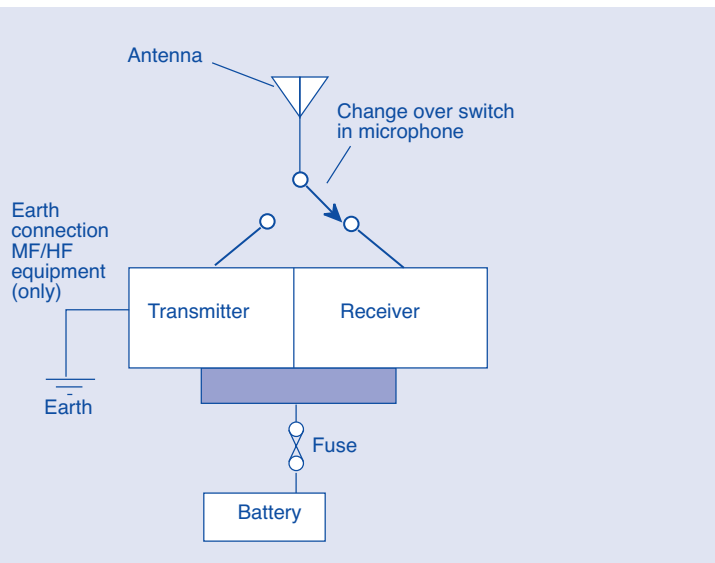

Figure 14.2 Antenna on a small vessel



Figure 14.3 A microphone is used to switch between transmit and receive modes



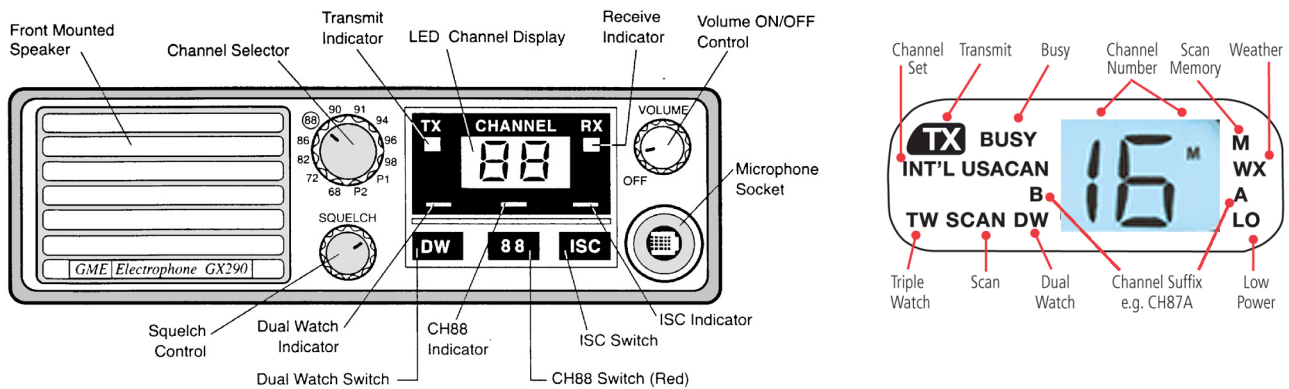

Figure 15.1 Common controls and functions (courtesy GME electrophone)

Fuses located in the wiring between the power supply and the transceiver protect the vessel and equipment from the likelihood of fire should an equipment fault occur.

## Transceiver controls

The following are the general controls that are found on most, but not all, radio transceivers.

- Channel selector. This control is used to select the channel or frequency that you wish to transmit or receive on.
- On/off and volume control. Turns the equipment on or off and controls the volume of signals coming from the loudspeaker.
- Squelch or mute control. Stops the constant and annoying background hiss or roar from the receiver. The correct setting is so that the hiss or roar just cannot be heard. Further rotation of this control will progressively desensitise the receiver.
- ISC switch. Interference suppression circuit (noise blanker). When this switch is activated it combines with a built in automatic noise limiter to eliminate electrical interference.
- Dual watch. This control will be found on most VHF receivers. On operation it will permit a listening watch on two different VHF channels. A light emitting diode (LED) will come on in some receivers when this control is operational.

### Additional controls not shown above

- AM/SSB control. Found on all MF/HF transceivers and some 27 MHz transceivers. It controls the mode of transmission and reception - either AM (amplitude modulation) or SSB (single sideband).
- RF gain. Some transceivers have this control. It is used to vary the strength of the incoming signal, similarly to the volume control. However it should normally be kept close to maximum and the volume control used to adjust signals to a comfortable level.
- Noise limiter. May be switched on to minimise the effect of loud static interference. Unfortunately, it will also

have the effect of desensitising the receiver to wanted signals.

- Power selector. Controls the power of your transmitted signal. A good operator never uses more power than is needed to successfully communicate with the desired station. Additional power will only cause unnecessary interference and drain your battery faster.
- Antenna or aerial tuning unit (A.T.U.) – see Figure 14.1 This unit may be built into the transceiver or provided as an extra unit. It will be found only on MF/HF equipment. Its purpose is to adjust the "electrical" (not physical of course) length of the antenna so that the antenna is matched to the transceiver on each channel or frequency and maximum transfer of power can take place.
- The A.T.U. may have one, two or three controls and will be provided with either a light or a meter. The control(s) should be adjusted to give maximum brightness of the light or in most cases, maximum deflection of the meter (Note that on some models, the controls should be adjusted for minimum deflection).
- Alarm signal generating device (A.S.G.D.) Found only on some MF/HF transceivers. Operation of this control will cause the radiotelephone alarm signal to be transmitted. A 'test' position may also be provided which permits the function to be tested without transmission.
- Press to talk control. This spring loaded control is located on the microphone. When pressed, it activates the transmitter section of the equipment permitting transmission of signals. When allowed to return to its normal position, the transmitter is deactivated and the equipment is restored to the receive mode.
- Clarifier. Found on MF/HF or 27 MHz equipment that use the single sideband mode of transmission and reception. It varies the tuning of the incoming (received) signal.

Should the incoming signal be difficult to understand then varying the clarifier control one way or the other should "clarify" that signal and make it intelligible. This control has no effect whatsoever on your transmitted signal.

# WORKSHEET 3 TRANSCEIVER CONTROLS

Complete the following table identifying the parts of the marine transceiver labelled 1–14 in Figure 16.1 below (courtesy GME electrophone). Some research may be necessary with your local rescue organisation.

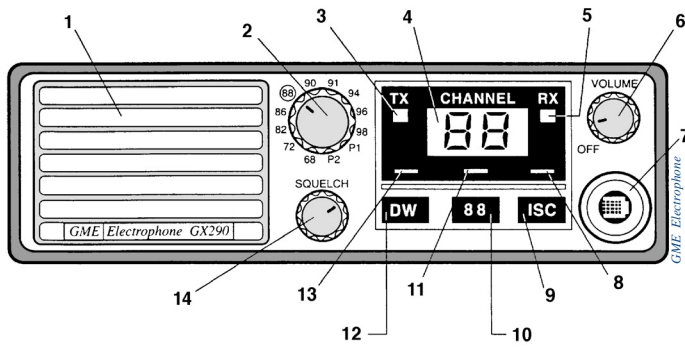

Figure 16.1

N <sup>o</sup>	Name	Function
1		
2		
3		
4		
5		
6		
7		
8		
9		
10		
11		
12		
13		
14		



# SECTION 5 TYPES OF MARINE RADIO

VHF sets are recommended these days due to their better performance

Small boat operators use radios to

- obtain up-to-date weather forecasts
- report arrival and departure times if going out to sea
- listen to fishing details
- communicate with shore stations and other vessels and
- listen to radio broadcasts advising of overdue vessels at sea.

Different frequencies have different uses which have resulted in three main types of marine communication equipment. These sets are:

- VHF
- 27 MHz sets
- MF/HF

All crew should be competent in the operation of the marine radios onboard, know the frequencies dedicated to distress and safety and be able to properly format and transmit distress and safety messages.

## VHF sets

This is the preferred radio for short range communications due to their better performance over 27MHz but require the operator to have a licence.

All large boats and an increasing number of smaller boats monitor the emergency Channel 16. A marine radio is normally left on Channel 16 to receive incoming calls or monitor distress signals.

## Frequencies

Areas with large boating populations usually have marine rescue stations monitoring Channels 16 and 67 on a 24 hr basis.

Weather information is regularly broadcast on Channel 67.

Most areas have a local 'chat' frequency or a common use re-broadcast frequency and Channel 73 is often used for this purpose.

## 27 MHz sets

**27 MHz sets** are so called because all of their channels are in the 27 megahertz band. The range of these sets is between 6 to 30 nautical miles but this can be reduced if one station is behind an island or atmospheric conditions are bad.

Small boat operators can use these to:

- obtain up-to-date weather forecasts
- report arrival and departure times if going out to sea
- listen to fishing details
- communicate with shore stations and other vessels
- listen to radio broadcasts advising of overdue vessels at sea.



Figure 17.1 VHF radio controls courtesy GME

## VHF fact file

1. Cost - a VHF set costs between \$250 and \$800.
2. A marine radio operator's certificate is required to operate these radios.
3. The advantage of a VHF set is the high quality sound which is not subject to atmosphere or engine interference.
4. If fitted with digital selective calling it will offer single button distress facility and automated watchkeeping.
5. A VHF station is covered by a class licence.

## VHf Marine channels

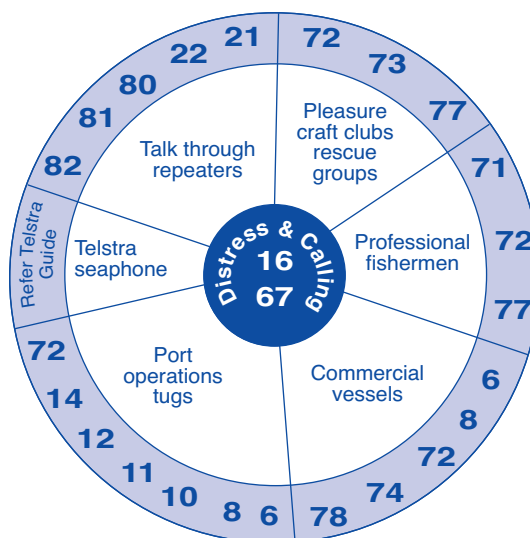

Figure 17.2 VHF marine channels diagram

Wet Paper

The radio is normally left on channel 88 to receive incoming calls or monitor distress signals.

- 27.88 MHz is used for initial contact and agreement is made to change to other frequencies.
- 27.86 MHz is a supplementary distress and calling channel and is used to transmit safety messages.

### Performance

Since 27 MHz sets are extremely low power the quality of the antenna is important. Poor performance of a radio can often be attributed to a poor quality or badly adjusted radio antenna and interference from the motor.

## MF/HF radio

These radios are so called because they operate in the medium frequency (MF) and high frequency (HF) ranges. The sets have the longest range and by far the greatest cost. They also transmit the greatest power of up to 400 watts. Ranges depend on the frequency band used:

- 2 MHz or 2,000 kilohertz band - 100-200 n miles
- 4 MHz or 4,000 kilohertz band - about 300 n miles
- 6 MHz or 6,000 kilohertz band -about 1000 n miles.

These are normal daytime ranges which are significantly increased during the night. These sets have all the controls of the radios discussed, but have a clarifier control to fine tune incoming signals. 2524 KHz is a popular working frequency in some areas.

The higher the frequency the greater the distance radio waves travel.

International radiotelephony distress and calling signals on MF/HF sets are:

- 2182 kilohertz
- 4125 kilohertz
- 6215 kilohertz
- 8291 kilohertz\*
- 12290 kilohertz\*
- 16420 kilohertz\*

### \*Update

As from 1 January 2004, 8291, 12290 and 16420 are limited to distress, urgency and safety purposes and should not be used for routine calling.

27 MHz Marine channels

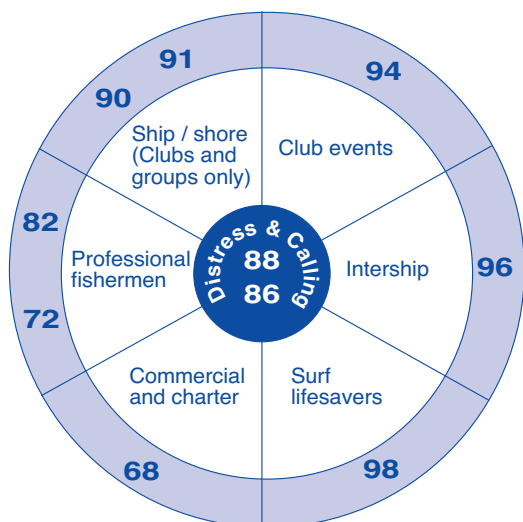

Figure 18.2 MHz marine channels diagram

Wet Paper



Figure 18.1 27 MHz radio (courtesy GME electrophone)

## 27 MHz fact file

1. Cost - a 27 MHz set costs between \$150 and \$250.
2. A marine radio operator's qualification is not required to operate these radios.
3. The radio set itself is covered by a class licence.
4. The 27MHz radios are simple to install.
5. Disadvantages of this type of set are that they are subject to interference from atmosphere and engine noise and can become very congested with radio traffic.

## MF/HF fact file

1. Cost - The MF / HF sets cost between \$2500 and \$4000.
2. A marine radio operator's qualification is required to operate these radios.
3. MF / HF sets can provide world-wide communication with correct choice of frequency.
4. These sets are complex to install and require large antennas.
5. Provide access to radiotelephone and radiotelegram services.
6. These sets can also be fitted with digital selective calling.
7. A MF/HF station requires an individual station licence.

# SECTION 6 DIGITAL SELECTIVE CALLING (DSC) COMMUNICATIONS

This technique has been used for several years by large trading vessels. It is expected that its use will gradually become commonplace by small vessels and eventually may replace radiotelephony techniques for initial distress, urgency and safety calls on the MF/HF marine and VHF bands.

With time, traditional labour-intensive aural watchkeeping by ship and limited coast stations may change to automated DSC electronic watchkeeping as the maritime communication stations have done.

Although maritime communication stations provide a service in the HF marine band, the use of MF/HF DSC by small vessels in Australia is still in its infancy. Many limited coast stations do not support this form of communications for small vessels. DSC on VHF is becoming more popular. However, normal radiotelephony procedures are likely to be the primary means of initiating priority calls to and from small vessels for some years. Maritime communication stations no longer monitor the MF and VHF radiotelephony bands. Therefore HF radiotelephony equipment fitted with DSC is recommended above other options.

While the main use of DSC by small vessels will be for distress, urgency and safety purposes, the technique may also be used for routine calling.

DSC is a semi-automated means of establishing initial contact between stations. Once this contact has been established, standard radiotelephony procedures are used for subsequent communications.

DSC can be used to initiate ship to ship, ship to shore, and shore to ship communications. Information transmitted by DSC is generally known as a DSC Alert which is:

- a brief burst (typically seven seconds on MF/HF, and 0.5 second on VHF) of digitised information transmitted from one station to alert another station or stations, and
- to provide some basic information.

## Information contained in a DSC alert

A DSC alert contains the following information as digitised data:

1. the identity of the calling station (a 9 digit identification number)
2. priority of the alert - distress, urgency, safety or routine and
3. the station being called (a specific station or a group of stations).

Position information may also be included.

The way in which the transmitted DSC alert is encoded by the initiating station determines which station or stations will decode the information.

Whilst all the stations listening on the DSC frequency will receive the alert, only the station(s) selected by the transmitting station will actually decode and have the message available. This will be signalled by an audible alarm to alert the operator.

The main use of the DSC is likely to be for safety communications where it can provide a one-step push-button in a distress situation.

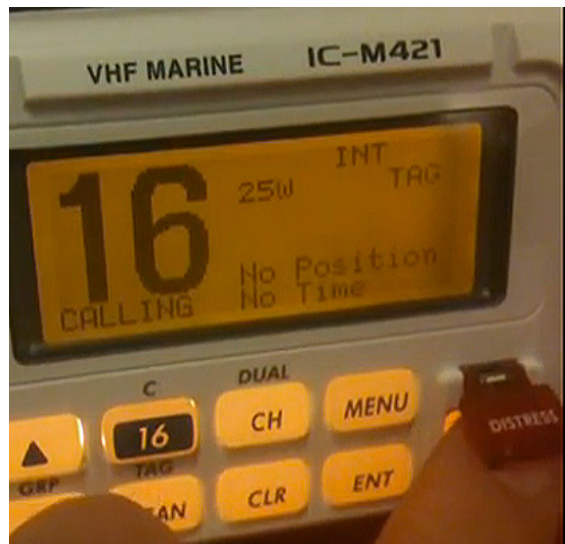

Figure 19.1 DSC distress button  
courtesy Uniden

## Research Activity - You Tube<sup>®</sup>

Go to You Tube<sup>®</sup> and search for digital selective calling. Play a video on selective calling or look up Mayday messages. Describe what happened and make a power point demonstration for your class.

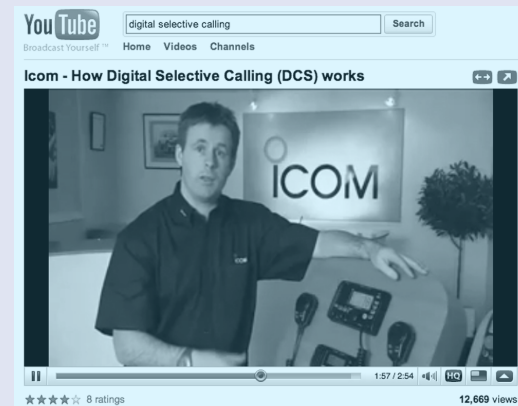

Figure 19.2 Research activity  
ICOM Communications

## Important information

The use of MF/HF DSC by small vessels in Australia is still in its infancy.

- At present, any person purchasing a MF/HF or VHF transceiver with DSC capability and wishing to use the option must obtain a MMSI which is issued by AMSA. This must then be programmed into the transceiver.
- See the AMSA website for more information (<http://www.amsa.gov.au/AUSSAR/AMSA89.pdf>).

## Digital distress / urgency alert

If the radio you are using has the digital selective calling capacity a DSC distress alert can be initiated.

This alert will contain the following information as digitised data:

- the identity of the calling station
- the priority of the alert - distress, urgency or safety
- the stations being called
- the position of the vessel (Latitude and Longitude).

Once selected and initiated, the DSC alert will be automatically repeated until it is turned off by the operator. The DSC alert may only be transmitted on the authority of the master or skipper or the person responsible for the safety of the vessel. The transceiver will normally be automatically interfaced with the satellite positioning equipment on the vessel and may also offer a button menu to select the nature of the distress eg. sinking, fire, etc.

### Steps to transmit a DSC distress alert and subsequent distress call and message

These are:

1. select the DSC distress channel. If time permits key in or select
  - nature of distress and
  - position of the vessel
2. initiate the distress alert
3. change to associated radiotelephony channel
4. send the radio telephony distress call and message as you would on a radio without DSC.

## Acknowledgement of receipt of a DSC distress / urgency alert

A radio operator receiving a DSC alert from another vessel should not normally acknowledge receipt by DSC as this is done by the coast or limited coast station.

The operator should immediately listen on the associated radiotelephony frequency for the distress message which should follow.

This should be done in accordance with the rules discussed in Section 9 on urgency calls.

### Cancellation of an inadvertent distress message

Since a DSC alert is a push-button process it is possible to inadvertently initiate an alert. Should this occur it is important that you immediately carry out the following procedures:

1. Immediately switch off the transceiver as this will cancel any automatic repeats of the DSC distress alert which would normally continue until the alert was acknowledged.
2. Switch the transceiver on and select the radio frequency on which the inadvertent alert was transmitted.
3. Broadcast to all stations on the appropriate frequency giving the vessel's name, call sign and cancellation of the distress alert.

## Transmission of a DSC safety alert

The transmission of a DSC safety alert indicates that the vessel or station has a message to transmit which contains an important navigational or weather warning. The DSC safety alert should be carried out by taking the following steps:

1. tune the transceiver to the appropriate DSC frequency
2. select the "all ship" call format
3. select the safety priority
4. transmit the DSC safety alert
5. select the associated radiotelephony channel
6. broadcast that a securite message is to follow on a working frequency
7. transmit a securite message on that frequency.

See section 9 on Urgency calls for the format of the message that would be sent.

### Note

- Stations receiving a DSC Safety Alert should not acknowledge it.

Instead they should tune their radio to the associated radio/telephony frequency/channel and await voice message.

## Other uses

Small craft users can purchase class D DSC equipment, which is useful for position polling- automatically reporting your position to a coast station.

### DSC fact file

- With the gradual change to DSC, the problem of hoax distress calls is likely to be eliminated. It is impossible to transmit a DSC alert without electronically identifying the initiating vessel.
- For a full discussion on Digital Selective Calling go to Section 16 of the ACA Manual. <http://amcom.amc.edu.au>
- DSC techniques will not be introduced into the 27MHz marine band.
- DSC frequencies:
  - MF / HF 2187.5, 4207, 6312, 8414.5, 12577, 16804 KHz
  - VHF 70
- The use of MF/HF DSC by small vessels in Australia is still in its infancy.



# WORKSHEET 4 TYPES OF CALLS

1. Complete the following table of channel usage

Type of call	27MHz	VHF	MF / HF
Distress and initial calling			
Supplementary distress and urgency			
Non-commercial			
Professional fishing service			
Commercial service (including charter vessels)			

2. What does the antenna in a marine radio equipment system do?

---



---

3. What does the power supply to a marine radio do?

---



---

4. Name three types of marine radio.

---



---

5. Name five uses small boat operators can make of a 27MHz radio transceiver.

---



---

6. What channel is a 27 MHz usually left on and why?

---



---

7. What channel is a VHF usually left on and why?

---



---

8. On what types of radio is a marine radio qualification required?

---



---

9. Why is it useful to have a marine radio qualification when you only have a 27 MHz equipment?

---



---

10. Complete the table on the advantages and disadvantages of different types of radios.

Radio Type	27MHz	VHF	MF / HF
Advantages			
Disadvantages			

# WORKSHEET 5 DIGITAL SELECTIVE CALLING

---

1. What do the abbreviations GMDSS and DSC stand for?

---

---

2. State two advantages of digital selective calling.

---

---

---

3. What information does a DSC alert contain?

---

---

4. Will digital selective calling be set up on 27 MHz equipment?

---

---

5. While the main use for DSC by small vessels will be for distress, urgency and safety purposes, what other uses can it have?

---

---

---

6. How is a ship station identified using DSC techniques?

---

---

7. How does a DSC system reduce the amount of calls received on a marine radio?

---

---

---

8. The use of DSC in small ships in Australia is in its genesis. What does this mean?

---

---

---

9. What are the international digital selective calling frequencies for VHF and MF / HF?

---

---

---

10. How will DSC techniques reduce watchkeeping by ships, coast and limited coast stations?

---

---

---

---

---

---

11. Write down in order the four steps to correctly transmit a digital selective calling distress alert and subsequent distress call and message if your vessel the *Anne Margaret* which is a 42 foot catamaran sailing across the Tasman Sea has just hit a submerged ship container and you are taking in water fast.

Your position is 100 nautical miles south-east of Sydney and there are three people on board.

The diagram consists of four empty rectangular boxes arranged horizontally, connected by right-pointing arrows. Each box contains several horizontal lines for writing.

12. How do you cancel an inadvertent DSC distress alert?

Four horizontal lines for writing the answer to question 12.

13. What action should be taken when an operator receives a DSC distress alert?

Five horizontal lines for writing the answer to question 13.

14. Write down in order the steps necessary to correctly transmit a digital selective calling safety alert and subsequent radiotelephony safety call and message.

Twelve horizontal lines for writing the answer to question 14.

# SECTION 7 MARINE RADIOTELEPHONY PROCEDURES

## Normal traffic operations

A radio is different from a telephone in that you cannot hear the other person while you speak and there is no private line. To avoid chaos it is obvious that there must be some standard operating procedure.

This section deals with normal traffic, safety signals, urgency signals and distress signals.

In making a normal call to another ship or coast station the most important points to remember are:

- SAY - (the other vessel's name) THREE TIMES
- SAY - (this is) ONCE
- SAY - (your boat's name and call sign) THREE TIMES
- SAY - OVER
- when he/she answers, agree on a working frequency
- after each transmission say OVER and then
- on completion of conversation SAY - OUT.

### Example

Two vessels *Reef Seeker* and *Tubby* set to sea and wish to meet for lunch at St. Bees Island.

About 11.30 am, *Reef Seeker* calls *Tubby* to find out what time she will be there.

The speech bubbles in Figure 24.2 give an indication of normal traffic operations.

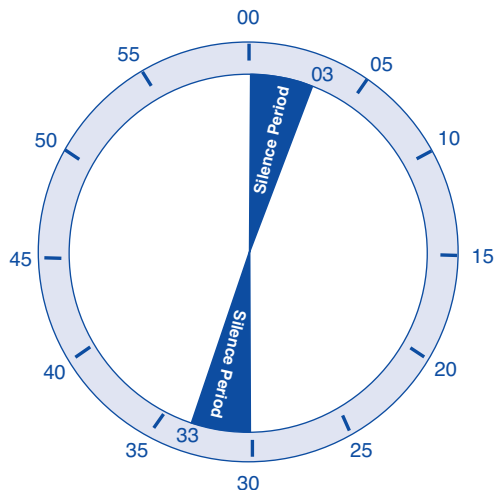

Figure 24.1 Three minute silence periods begin every hour and after every half hour

Wet Paper

### But why three times?

Suppose you are fishing some distance near the stern from your radio and you hear what you think is someone trying to call you. The first call alerts you, the second and third call confirm that the call is for you. When you begin this may seem silly, but when you are out at sea, hearing on a radio is very difficult.

### Local practices

In many local areas it is common practice to only say vessel names and call signs twice. The local Coastguard says this is acceptable procedure, but that names should be spoken three times if radio signals are not clear.

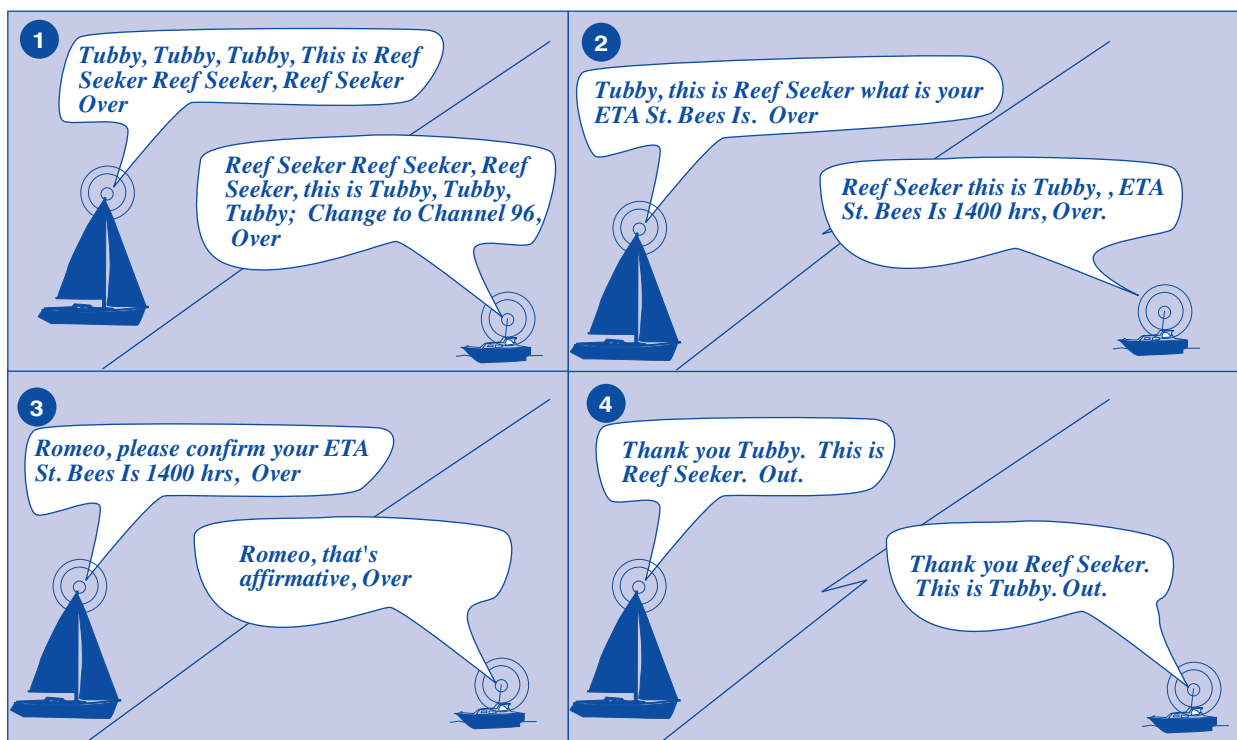

Wet Paper

Figure 24.2 Standard radio communication procedure between two ship stations



## Radio silence periods

Before using a radio, the operator should always glance at a watch or clock to see if it is an official radio silence period. These are three minutes beginning every hour and every half hour. This allows operators to hear weak signals that may be seeking help.

With the exception of distress calls and messages all transmissions from all stations must cease during these radio silence periods on 2182 KHz.

However normal practice in Australia is to observe silence periods on all distress frequencies.

## Good operating procedures

(Adapted from voluntary marine rescue notes.)

Effective communication on the marine radio relies on the operator following good operating procedures.

### Have a good knowledge of your equipment

- The types of equipment were discussed in the previous section. You need to understand the radio's capacities and limitations.
- The range on these marine radios vary from type to type and the quality of reception also varies. It is important to understand the functions of the different switches and knobs on the marine radio. Maintenance of this equipment is important and this will be discussed in a later section.

### Observe the regulations

- The marine radio regulations are in place for everyone's good. It allows for more effective communications which can save lives at sea.
- These regulations ensure you get the best service from your equipment and more successful communications.

### Keep a log

- Operators should keep a record of all distress alerts and messages transmitted or received. A sample radio log is supplied in worksheet 22 on page 59.



Figure 25.1 Most base stations keep a log of all calls

## Use the correct frequencies

- As discussed in the previous section it is important that frequencies are used only for the purpose for which they are assigned e.g. 27.88 MHz is the distress and urgency frequency on the 27 MHz radio and it should not be used by local fishermen for discussion of catch or general conversation.

### Listen before you talk

- It is important that once the set has been turned on and you have selected the frequency you wish to use that you pause for a short time to make sure some other operator is not using this frequency.
- Remember that when you transmit, all other vessels with their radio tuned to this frequency will hear your message.

### Be brief

- Transmission should be kept as brief as possible. The marine radio should not be used for social pleasantries and unnecessary conversation should be avoided. Remember all radio operators on that channel can hear your conversation.

### Maintain a watch

- It is important to listen on the distress channels as much as possible. The more operators listening on these channels the better the chance of a weak distress message being received.

### Identify yourself

- When establishing communications on the radio it is important that in the initial call you give your name and/or call sign and also identify the operator you wish to contact.
- Transmission without identification is strictly forbidden.

### Be aware of who controls transmissions

- The master or skipper, or the person responsible for the safety of the vessel has the authority to use and transmit messages.

### Maintain secrecy of communications

- Under the International Radio Regulations an operator and any other person who gains knowledge of the contents of a radiotelegram or radiotelephone is under an obligation to preserve the secrecy of this information.

### Watch your language

- Profane or obscene language has no place on the air. It is an offence to use this language on the airways. False or deceptive distress, urgency or safety signals is also strictly forbidden.

Severe penalties are in place for any persons found guilty of making a false distress, urgency or safety call including imprisonment.

## Radio terminology

- AFFIRMATIVE Yes
- NEGATIVE No
- ETA Estimated time of arrival
- ETD Estimated time of departure
- OVER My transmission is ended and I expect a response from you.
- OUT My transmission is ended and no response is expected.
- STAND-BY Wait and listen till I re-transmit
- STANDING -BY I am waiting for you to call me again.
- CQ General call to all stations. Hello all stations. Used in Morse.
- ROMEO Message received and understood.
- WILCO Message received and will carry out instructions.
- ACKNOWLEDGE Let me know that you have received and understood the message.
- GO AHEAD Proceed with your message
- I SAY AGAIN Self explanatory
- SAY AGAIN Repeat your message.
- THAT IS CORRECT Self explanatory
- VERIFY Check your information and advise me.

Avoid CB terms such as — come in please, over and out, come back, ten-four etc.

## Phonetic alphabet

Sometimes when radio reception is poor it may be necessary to spell words or numbers. To do this the phonetic alphabet is used and summarised below.

The syllables to be emphasised are underlined.

### Numbers

Numbers should be transmitted by saying one number at a time e.g. 250 litres should be spoken as two five zero litres.

### Time

Time is usually expressed in 24 hour time e.g. 6 pm is 1800 hours.

LETTER	PHONETIC	Spoken as	LETTER	PHONETIC	Spoken as	LETTER	Code	Spoken as
A	ALPHA	<u>Al</u> fa	B	BRAVO	<u>Brah</u> vo	0	Zero	ZEEROH
C	CHARLIE	<u>Char</u> lee	D	DELTA	<u>Dell</u> tah	1	One	WUN
E	ECHO	<u>Eck</u> oh	F	FOXTROT	<u>Foks</u> trot	2	Two	TOO
G	GOLF	<u>Golf</u>	H	HOTEL	<u>Hoh</u> tell	3	Three	TREE
I	INDIA	<u>In</u> dee ah	J	JULIETT	<u>Jew</u> lee ett	4	Four	POWER
K	KILO	<u>Key</u> loh	L	LIMA	<u>Lee</u> mah	5	Five	FIFE
M	MIKE	<u>Mike</u>	N	NOVEMBER	<u>Nov em</u> ber	6	Six	SIX
O	OSCAR	<u>Oss</u> cah	P	PAPA	<u>Pah</u> Pah	7	Seven	SEVEN
Q	QUEBEC	<u>Keh</u> bek	R	ROMEO	<u>Roh</u> me oh	8	Eight	AIT
S	SIERRA	<u>See</u> air rah	T	TANGO	<u>Tang</u> go	9	Nine	NINER
U	UNIFORM	<u>You</u> nee form	V	VICTOR	<u>Vik</u> tah	10	One zero	WUNZEEROH
W	WHISKEY	<u>Wiss</u> key	X	X-RAY	<u>Ecks</u> ray	1000	Thousand	TOUSAND
Y	YANKEE	<u>Yank</u> key	Z	ZULU	<u>Zoo</u> loo	Decimal	Decimal	DAY-SEE-MAL
						Full stop	Stop	STOP

Figure 26.1 Phonetic alphabet. The syllables to be emphasised are underlined.

## Signal strength

### How do you read me?

- I read you ..... With signal strength .....
- (bad : ..... /1) (1 / barely heard)
  - (poor : ..... /2) (2 / weak)
  - (fair : ..... /3) (3 / satisfactory)
  - (good : ..... /4) (4 / good)
  - (excellent : .. /5) (5 / excellent)



Figure 26.2 A great way to learn how to use a marine radio is by joining a volunteer organisation

## Example of a radio check

- Call on channel 16
- Redcliffe Coast Guard, Redcliffe Coast Guard, Redcliffe Coast Guard, this is Reef Seeker, Reef Seeker (OVER)
- Reef Seeker this is Redcliffe Coast Guard please switch to Channel 73.
- Redcliffe Coast Guard, this is Reef Seeker Reef Seeker, just fitted a new VHF radio and wanting a radio check (OVER)
- Reef Seeker this is Redcliffe Coast Guard your signal strength is FOWER to FIFE (OVER)
- Redcliffe Coast Guard, this is Reef Seeker Reef Seeker, thank you (OUT)
- Reef Seeker this is Redcliffe Coast Guard (OUT)

## Voice procedures

It is essential to have effective voice procedures so that good radio communications can take place. Even holding the microphone in the correct way can improve the voice quality.

A hand-held microphone should be held in the palm of the hand and the thumb or finger used to operate the press-to-talk button. The thumb should just be touching the cheek and the idea is to talk directly into the microphone. It is important to keep the head still as head movement away from the microphone while speaking will cause inconsistent voice quality.

The four basic factors to remember when using a radio are:

Rhythm, speed, volume and pitch

Remember RSVP.

### Volume

- The operator should speak slightly louder than in ordinary conversation but not shout.
- All words should receive equal emphasis and you should not drop the voice at the end of the sentence.

### Rhythm

- Maintain a constant rhythm as speaking too quickly or too slowly makes it more difficult to understand. Any phrase spoken in ordinary conversation has a natural rhythm and this should be preserved when speaking on

the radio. You should not simply say one word at a time, pausing between each word.

- Care must be taken not to say the word 'um' or 'er' etc after a word or phrase. It will help if you think about the message you are to give before you transmit so that you have a clear and concise message.

### Speed

- The operator must talk steadily at a medium speed. If the operator speaks too quickly the message becomes a jumble of words. This speed needs to be adhered to in the distress situation when panic has a way of speeding up your thoughts and words.
- If you speak too slowly it may exasperate the listener and waste valuable time. The speed should be kept constant throughout.
- If you are dictating a message make sure that you pause between phrases so that the recorder can write down the message.

### Pitch

Higher pitched voices are often transmitted more successfully than those of a lower pitch. This is why radio operators used in taxi control centres, telephone service operators, etc are often females.



Figure 27.1 Effective voice procedures are transferrable to other skills in the maritime industry

# WORKSHEET 6 MARINE RADIO

based on an original worksheet by Mark Collins, Maryborough State High School



1. Match up the word from list A with one in list B

List A

- Verify
- ISC switch
- VHF distress channel
- 27 MHz distress channel
- Squelch control
- ROMEO

List B

- Reduce to one channel
- 27.88 MHz
- 27.80 MHz
- Check your information and advise me
- Eliminates electrical interference
- Message received and understood
- Repeat your message
- Channel 16
- Reduces background noise

2. Complete the phonetics for the following letters.

K

N

W

F

O

D

I

L

3. Unscramble the following letters to find a marine radio related word.

a. RAILEA

b. ETMNRRTISAT

c. NNNARETA

d. CPNIOOMRHE

e. ROEWP

f. TEHZR

g. WSEVA

h. LAIGSN

i. EMIRAN

j. ROIDA

4. Discuss four important voice procedures that are needed for good voice communications.

---

---

---

---

5. Why are radio silence periods enforced and when do they occur?

---

---

---

6. Why is it important to maintain a watch on your radio?

---

---

---

# WORKSHEET 7 TUNING A MARINE TRANSCEIVER

based on an original exercise by Mark Rickard, Benowa State High School  
(Should only be performed under the control of a qualified marine radio operator.  
See also Section 7)

## You will need

- A radio box or radio set as shown in Figure 29.1
- To protect your sea safety investment (the radio), ensure that microphone and antenna connections are secured before proceeding.
- If constructing a mobile unit as shown in Figure 29.1, make sure the following are observed:
  - a. Cover the tip of the antenna with a protective cap to prevent eye gouging.
  - b. If marine batteries are used, make sure two people are involved in lifting to prevent back injuries and that terminals are not shorted.
  - c. Make sure the unit does not fall over spilling the battery acid.
  - d. Make sure connections are in good order and repair by checking each time the unit is used.

## What to do

1. Select appropriate power switch and turn receiver on.
2. Use the channel selection control to choose appropriate calling frequency (27.88/27.86, VHF 16/67)
3. Identify the squelch control and turn to maximum (usually anticlockwise).
  - Adjust volume control to audible level.
  - Adjust the squelch until crackling noise is suppressed, ensuring that you fine tune this control to only just suppress interference so as to ensure maximum sensitivity.
4. Before transmitting, listen carefully for long enough to be satisfied that interference will not be caused to a station already using that channel.
5. Check the time to ensure a radio silence period is not operational.
6. You are now ready to transmit.



Figure 29.1 Tuning a marine radio using a mobile 27 MHz base station

# WORKSHEET 8 SENDING A MESSAGE

---

Answer the questions below.

1. a. Why is it necessary to say the vessel's name three times?

\_\_\_\_\_

b. What is normal local radio procedure?

\_\_\_\_\_

2. What is the most commonly used radio frequency in your area for transmitting local traffic?

\_\_\_\_\_

3. On what channel do operators listen in for messages?

\_\_\_\_\_

4. To what channel do they normally transfer?

\_\_\_\_\_

5. How would you say each of the following?

- |           |            |
|-----------|------------|
| • 21      | • \$131.34 |
| • 6.34    | • 14       |
| • 6 am    | • 12 noon  |
| • 3.35 pm | • 10.25 pm |

6. You are leaving port with three children and two adults on board. Your vessel is the *Tubby* and you are travelling 12Nm to St. Bees Island. You intend getting there at 10.30 in the morning. Write out your message to the local rescue station.

\_\_\_\_\_

\_\_\_\_\_

\_\_\_\_\_

\_\_\_\_\_

\_\_\_\_\_

\_\_\_\_\_

\_\_\_\_\_

\_\_\_\_\_

\_\_\_\_\_

\_\_\_\_\_

\_\_\_\_\_

\_\_\_\_\_

\_\_\_\_\_

\_\_\_\_\_

\_\_\_\_\_

\_\_\_\_\_

\_\_\_\_\_

\_\_\_\_\_

\_\_\_\_\_

\_\_\_\_\_

\_\_\_\_\_

\_\_\_\_\_

\_\_\_\_\_

\_\_\_\_\_

7. You want to test if your radio is working with the local rescue organisation. Write out your message to the local rescue station.

\_\_\_\_\_

\_\_\_\_\_

\_\_\_\_\_

\_\_\_\_\_

\_\_\_\_\_

\_\_\_\_\_

\_\_\_\_\_

\_\_\_\_\_

\_\_\_\_\_

\_\_\_\_\_

\_\_\_\_\_

\_\_\_\_\_

\_\_\_\_\_

\_\_\_\_\_

\_\_\_\_\_

\_\_\_\_\_

\_\_\_\_\_

\_\_\_\_\_

\_\_\_\_\_

\_\_\_\_\_

\_\_\_\_\_

\_\_\_\_\_

\_\_\_\_\_

# WORKSHEET 9 PHRASES AND MEANINGS



Complete the following table

Phrase	Meaning
	Yes
Negative	
	Estimated time of arrival
ETD	
	My transmission is ended and I expect a response from you
Out	
	Wait and listen till I re-transmit
Standing by	
	Message received and understood
	Let me know that you have received and understood the message
Go ahead	
I say again	
Say again	
That is correct	
	Check your information and advise me
CQ	
Wilco	

# WORKSHEET 10 PHONETIC ALPHABET

---

1. Explain why the use of phonetic alphabet is recommended at times when radio communications is difficult. Why not ask the operator simply to spell the words?

---

---

2. Suggest a reason for the emphasis of the underlined syllables when using certain words.

---

---

3. Divide the following into syllables:

- Preparation
- Communication
- Radio
- Station

---

---

---

---

4. Your boats name is *Sea Witch 2* and you have been requested to use the phonetic alphabet to give your boat name. Give your boat name.

---

---

5. Write your own name on the front of your notebook using the phonetic alphabet.

---

---

6. Write a message to the student next to you using the phonetic alphabet.

---

---

---

---

---

---

7. It has been suggested by a fellow student to change the word for the letter B from Bravo to Boat. Could this be done and could there be problems with this?

---

---

---

---

8. Common radio terms are ETA and ETD. What do these terms stand for and where might they be commonly used?

---

---

---

9. Suggest why the phonetic alphabet was developed and why some of the words were selected.

---

---

---

10. Why is it important to keep your message as brief as possible?

---

---



# SECTION 8 ALARM

## SIGNALS AND DISTRESS COMMUNICATIONS

A Mayday indicates that the vessel or person using it is threatened by grave and imminent danger and requests immediate assistance.

### Definition and priority of distress

- A distress call has absolute priority over all other transmissions and indicates that the vessel or person using it is threatened by grave and imminent danger and requests immediate assistance. All stations which hear a distress call must immediately cease all transmissions capable of interfering with distress communications, and must continue to listen on the frequency on which the distress call was received. A distress call is not addressed to a particular station.
- The obligation to accept distress calls and messages is absolute and must be accepted with priority over all other radio communications.

### Authority to transmit distress calls and messages

- A radiotelephony alarm signal, a distress call and a distress message from a vessel may be transmitted only on the authority of the master or skipper, or the person responsible for the safety of that vessel.

### Frequencies for distress

International frequencies for distress calls by radiotelephony are:

- 2182, 4125, 6215, 8291, 12 290, 16 420 kHz in the MF/HF marine bands; and
- channel 16 in the VHF marine band. (VHF channel only)

In Australian waters the following additional radiotelephony distress frequencies have been allocated:

- channel 67 in the VHF band (supplementary to channel 16);
- 27.88 MHz (channel 88) in the 27 MHz marine band; and
- 27.86 MHz (channel 86) in the 27 MHz marine band (supplementary to channel 88). (VHF channel only)

The distress frequencies in the 27 MHz marine band are monitored by the majority of limited coast stations operated by marine rescue groups. The distress frequencies in the 27 MHz marine band are not monitored by coast stations.

In the interests of safety, boat owners should ensure their equipment has the distress frequencies necessary to communicate with coast or limited coast stations in their area of operation.

### The distress signal

The radiotelephony distress signal consists of the word "MAYDAY".



Figure 33.1 Distress situation

This signal indicates that the vessel or person using it is threatened by grave and imminent danger and requests immediate assistance.

The distress signal must not be used under any other circumstances.

It should be noted that use of the distress signal is only justified if the vessel or person using it is threatened by grave and imminent danger.

It does not extend to situations where immediate assistance is sought on behalf of a person for example, a medical emergency. The urgency signal should be used in these situations.

Misuse of the distress signal could result in attention being diverted away from a situation which really requires immediate assistance.

### The distress call

The radiotelephony distress call consists of:

- the distress signal MAYDAY, spoken three times
- the words THIS IS (or DE spoken as Delta Echo in case of language difficulties)
- the name and call sign of the vessel in distress, spoken three times.

## The distress message

The distress message consists of:

- the distress signal MAYDAY
- the name and call sign of the vessel in distress
- particulars of its position
- the nature of the distress and the kind of assistance desired
- any other information which may facilitate rescue.

The distress call and message may be repeated as often as necessary, especially during silence periods, until an answer is received.

If no answer is received on distress frequencies, the message should be repeated on any other available frequency where attention might be attracted.

An example of a distress message is shown in Figure 34.1

## Distress position information

Position information in a distress message should normally be stated in one of three ways:

- latitude and longitude (degrees and minutes and decimal points of a minute if necessary, North or South, East or West); or
- a true bearing and distance (the unit of distance should always be specified for example, nautical miles or kilometres) from a known geographical point; or
- a precise geographical location (for example, in the case of a vessel running aground).

Where latitude and longitude are not used, care must be taken to ensure that the position given cannot be confused with any other place or geographical point.

If afloat and drifting, the rate and direction of drift could be stated in the distress message.

## Obligation to acknowledge receipt of a distress message

Ship stations which receive a distress message from another vessel which is beyond any possible doubt, in their vicinity, should immediately acknowledge receipt.

However, in areas where reliable communications with a coast or limited coast station is practicable, ship stations should defer this acknowledgement for a short interval to allow the coast or limited coast station to acknowledge receipt.

Ship stations which receive a distress message from another vessel which, beyond any possible doubt, is not in their vicinity should defer their acknowledgement to allow vessels nearer to the distressed vessel to acknowledge without interference.

Ship stations which receive a distress message from another vessel which, beyond any possible doubt, is a long distance away, need not acknowledge receipt unless this distress message has not been acknowledged by any other station.

When a ship station hears a distress message which has not been acknowledged by other stations, but is not itself in a position to provide assistance, it should acknowledge the

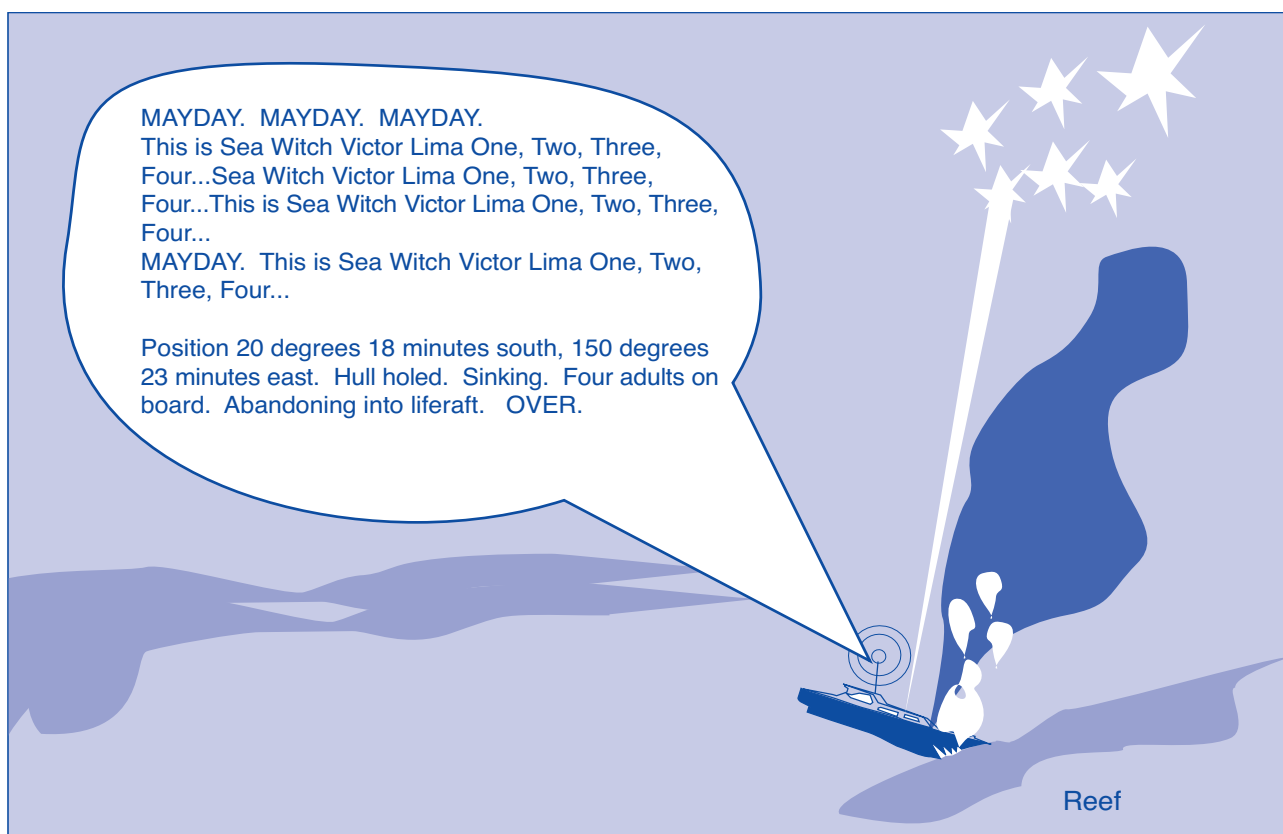

Figure 34.1 Distress message

call and then take steps to attract the attention of a coast station, limited coast station or vessels which might be able to assist. Details of how this should be done may be found on page 36 under the heading **Transmission of a distress message by a station not itself in distress.**

## Acknowledgement of receipt of a distress message

Acknowledgement of receipt of a distress message by a vessel, coast or limited coast station is made in the following way:

- the distress signal MAYDAY
- the name and call sign of the station sending the distress message, spoken three times
- the words THIS IS (or DE spoken as Delta Echo in case of language difficulties)
- the name and call sign of the station acknowledging receipt, spoken three times
- the word RECEIVED (or ROMEO ROMEO ROMEO in the case of language difficulties)
- the distress signal MAYDAY.

As soon as possible after this acknowledgement a ship station should transmit the following information:

- its position
- the speed at which it is proceeding and the approximate time it will take to reach the distress scene.

## Distress traffic

Distress traffic consists of all communications relating to the immediate assistance required by the vessel in distress, including search and rescue and on-scene communication. The distress signal MAYDAY should be used to precede each call and message.

## Control of distress traffic

The control of distress traffic is the responsibility of the vessel in distress. However, this station may delegate the control of distress traffic to a vessel, coast or limited coast station.

The vessel in distress or the station in control of distress traffic may impose silence on any or all stations interfering with distress traffic by sending the instruction SEELONCE MAYDAY.

This instruction must not be used by any station other than the vessel in distress, or the station controlling distress traffic.

If another station near the distressed vessel believes that silence is necessary it should use the instruction SEELONCE DISTRESS followed by its own name and call sign.

Any station which is aware of distress traffic, and is not taking part in it, is forbidden to transmit on any frequency which is being used for that traffic.

Ship stations not involved in the exchange of distress traffic may, while continuing to monitor the situation, resume

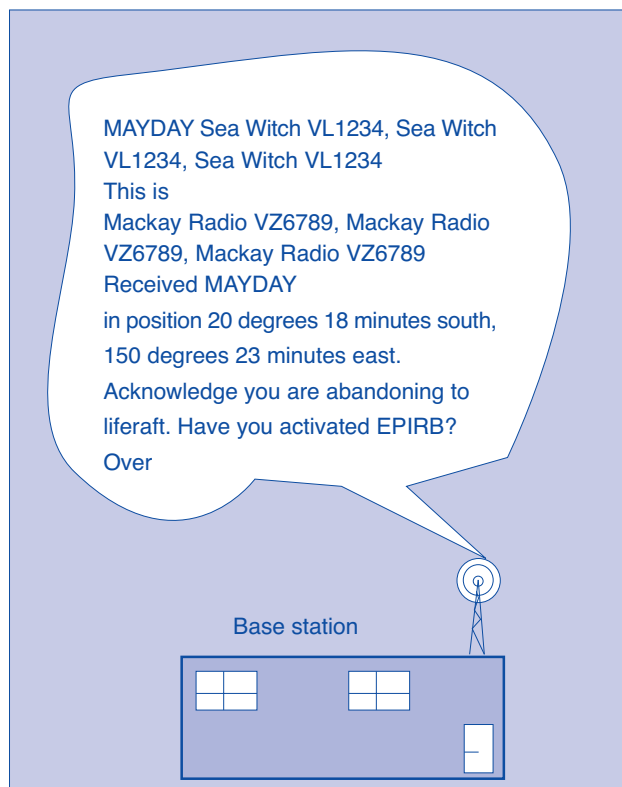

Figure 35.1 Example of acknowledgement of a distress message by a ship station (transmitted in response to the distress call and message in the example given in Figure 34.1)

normal radio service when distress traffic is well established and on the condition that distress traffic frequencies are not used and no interference is caused to distress traffic.

## Resumption of restricted working

Should the station controlling distress traffic consider that complete silence is no longer required on the distress frequency, the station should transmit on that frequency a message addressed to all stations indicating that restricted working may be resumed. Ship stations may then resume use of the distress frequency for normal purposes, but in a cautious manner and having regard that the frequency may still be required for distress traffic.

The message to announce resumption of restricted working should take the following form:

- the distress signal MAYDAY
- the call HELLO ALL STATIONS (or CQ spoken as Charlie Quebec), spoken three times
- the words THIS IS (or DE spoken as DELTA ECHO in the case of language difficulties)
- the name and call sign of the station sending the message
- the time the message originated
- the name and call sign of the vessel in distress;
- the word PRU-DONCE.

## Resumption of normal working

When distress traffic has ceased on a frequency which has been used for distress traffic, the station which has been controlling that traffic should transmit a message addressed to all stations indicating that normal working may be resumed. The message to announce resumption of normal working should take the following form:

- the distress signal MAYDAY
- the call HELLO ALL STATIONS (or CQ spoken as Charlie Quebec), spoken three times
- the words THIS IS (or DE spoken as DELTA ECHO in the case of language difficulties)
- the name and call sign of the station sending the message
- the time the message originated
- the name and call sign of the vessel which was in distress
- the words SEELONCE FEENEE.

## Transmission of a distress message by a station not itself in distress

A ship station, a limited coast station or a coast station which learns that a vessel is in distress may transmit a distress message on behalf of that vessel when:

- a. the vessel in distress cannot itself transmit a distress message; or
- b. the master or skipper of the vessel not in distress, or the person responsible for coast or limited coast station, considers that further help is necessary; or
- c. although not in a position to provide assistance, it has heard a distress message which has not been acknowledged (see page 35)

When a distress message is transmitted by a station not in distress, it is essential that this fact be made clear. Failure to follow the correct radio procedures could cause confusion and delays or, in the worst case, assistance to be directed to the wrong vessel.

A distress message transmitted by a vessel, coast or limited coast station not itself in distress should take the following form:

- the signal MAYDAY RELAY, spoken three times
- the words THIS IS (or DE spoken as DELTA ECHO in case of language difficulties)
- the name and call sign of the station making the transmission, spoken three times.

In the circumstances outlined in (a) and (b) above this transmission should be immediately followed by a suitable message in which the position and circumstances of the distressed vessel are provided. If the transmission is made by a vessel arriving at the distress scene to find rescue is beyond its resources then the transmission should be followed by a message outlining these circumstances and providing the real vessel's own position. In the circumstance outlined in (c) above, the transmission should be followed by a repeat of the original distress message.

If facilities are available, the radiotelephony alarm signal should precede the transmission.

A ship station should not acknowledge receipt of a Mayday Relay message transmitted by a coast or limited coast station unless definitely in a position to provide assistance.

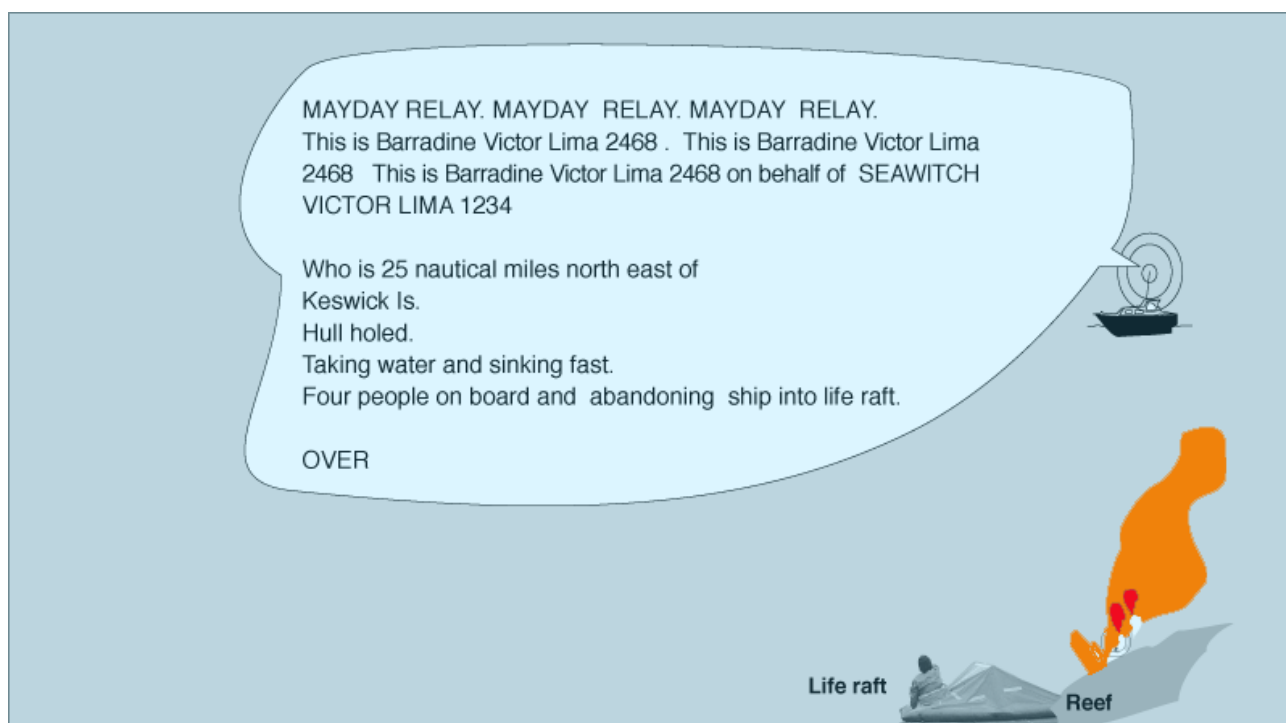

Figure 36.1 Transmission of a distress message by a station not itself in distress

## Radiotelephony alarm signals

The purpose of a radiotelephony alarm signal is to attract the attention of other marine radio operators that a message is about to follow.

The alarm signal, when activated consists of two audible frequency tones, one high, one low that are transmitted alternatively.

This produces a distinctive 'warbling tone' which is easily identified even when the reception is poor. This warbling tone will last for 60 seconds on the channel selected.

The alarm signal from a coast station will be followed by a single low tone lasting for 10 seconds. This identifies the transmission is coming from a coast station.

If your radio has an alarm generator it can be used to alert other marine radio operators of an important message you are about to send.

The radiotelephony alarm may be used before you send

- a distress call
- an urgency call under certain circumstances
- an urgent cyclone warning transmitted by a coast station.

## Other distress signals

Distress signals are used to attract attention to emergency situations at sea. Examples of some of these distress signals are shown in Figure 37.1 below.

The purpose of a radiotelephony alarm signal is to attract the attention of other marine radio operators that a message is about to follow.

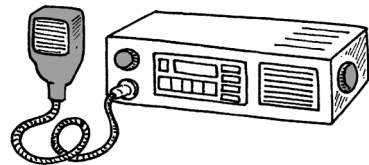











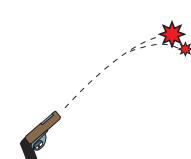
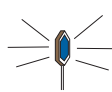

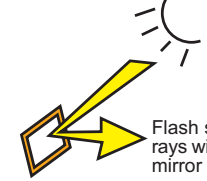
 <p>A gun or other explosive signal fired at intervals of about a minute</p>	 <p>A continuous sounding with any fog-signalling apparatus</p>	 <p>Activation of an EPIRB</p>	 <p>Flash sun's rays with signal mirror</p>
 <p>Rockets or shells throwing red stars fired one at a time at short intervals</p>	 <p>A signal made by any other signalling method consisting of the group (SOS) in the morse code</p>	 <p>A signal send by radio telephony consisting of the spoken word "Mayday" or a DSC alert</p>	
 <p>The International code signal of distress indicated by N.C</p>	 <p>Flames or smoke on the vessel (as from a burning tar barrel, oil barrel etc.)</p>	 <p>Rocket parachute flare or a hand flare</p>	 <p>Flashing torch</p>
 <p>Distress Signals (Merchant Ship Search and Rescue Manual)</p>	 <p>Slowly and repeatedly raising and lowering arms outstretched to each side</p>		

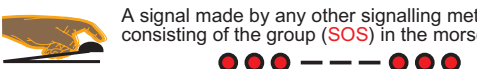
Figure 37.1 Distress signals

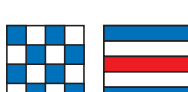
# WORKSHEET 11 RADIO TELEPHONY ALARM SIGNALS

1. What is the purpose of a radiotelephony alarm signal?

---

---

---

2. What type of sound do you hear if you receive a radiotelephony alarm signal?

---

---

---

3. How is the radiotelephony alarm signal transmitted by a coast station different to one produced by a vessel at sea?

---

---

---

4. Describe an alarm signal that is used to precede an urgent cyclone or storm warning?

---

---

5. Complete the diagrams below of common distress signals.

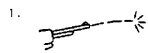

---

---

---

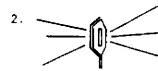

---

---

---



---

---

---



---

---

---



---

---

---



---

---

---



---

---

---



---

---

---



---

---

---

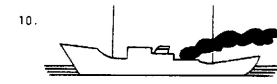

---

---

---



---

---

---



---

---

---



# SECTION 9 URGENCY, SAFETY CALLS AND SIGNALS

National and international systems exist to provide prompt and effective search and rescue assistance to ships in distress. By complying with the procedures outlined below communications will be more efficient. These urgency calls should be spoken clearly and not rushed.

## Urgency signals - Pan Pan

An urgency signal indicates that the station sending it has a very urgent message to transmit concerning the safety of a ship or aircraft, or the safety of a person. Urgency messages are sent on all distress frequencies and are identified by the words PAN PAN - PAN PAN - PAN PAN -

Note the following sequence:

- Pan Pan (three times)
- Hello all stations (three times)
- This is (name of vessel three times)
- Urgency message details (once).

Figure 39.1 shows an example of a urgency signal.

The urgency message and the message following should be sent on distress frequencies (except for long messages or medical messages which should be sent on working frequencies).

The message may be addressed to a particular station or to all stations as indicated in the example in Figure 39.1. If addressed to all stations, the station sending the message must cancel it with the same identification when action is no longer necessary.

## Safety signals - Securite

The safety signal consists of the word SECURITE (pronounced SAY-CURE-E-TAY). It indicates that the station using it is about to transmit a message concerning an important navigational or weather warning. It should not be used to precede routine weather forecasts.

Ship stations hearing the safety signal should continue to listen until they are satisfied that it does not concern them. They must not make any transmission that is likely to interfere with the message.

The safety signal and a call to all stations should normally be made on a distress frequency. However, the safety message that follows should be made on a working frequency or channel. Here is an example of a safety signal:

- SAY-CURE-E-TAY (three times)
- Hello all stations (three times)
- This is (once)
- Name of vessel (three times)
- Indication of channel, safety message follows - change channels
- Safety message, then out.

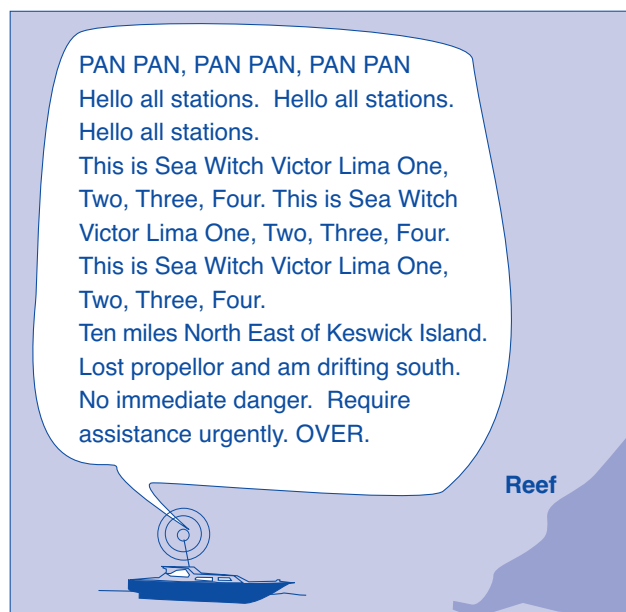

Figure 39.1 An example of an urgency signal

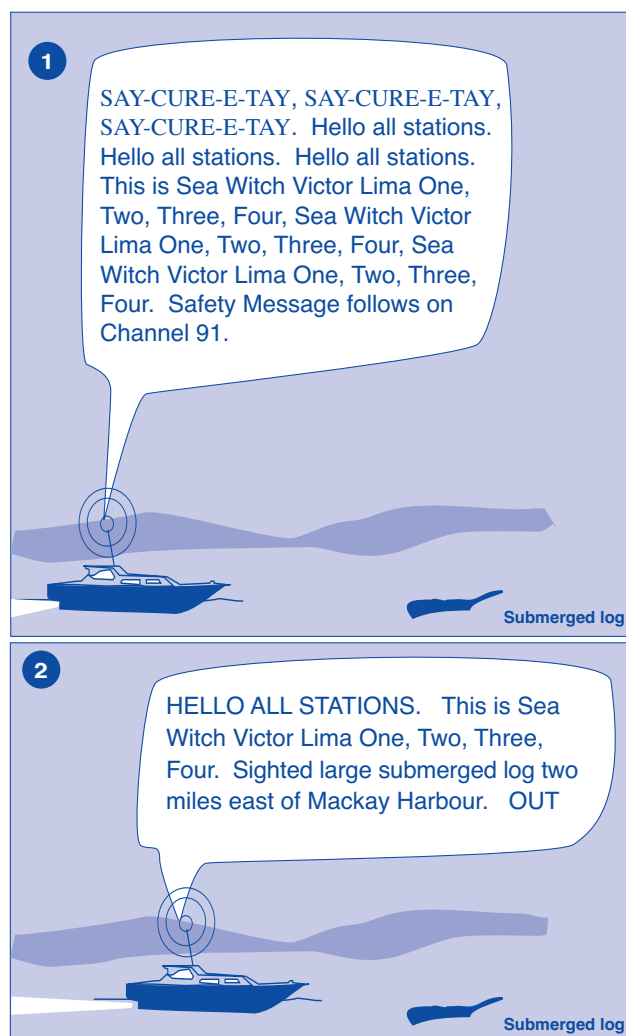

Figure 39.2 An example of a safety message

# WORKSHEET 12 DISTRESS SIGNALS

1. You are out at sea and have a distress situation on your vessel. The battery on your boat is not functioning and the radio is dead. You have no EPIRB on board the vessel.

Suggest two types of signal you would use in the following situations. Explain the reason for your choice.

At night	Sunny day	Foggy morning	Cloudy day

2. You have just hit a submerged reef and your vessel is taking water rapidly. It is a sunny day and you spot a large trawler in the distance but you are unable to locate your signalling mirror.

Suggest an alternative signalling device that may be on the vessel to attract the vessel's attention using the sun's rays.

---



---

3. What is the Morse code for S.O.S. or distress? Why is this method seldom used these days?

---



---

4. Who has the authority to send a Mayday message on a vessel's radio?

---

5. Select one of the following topics to research in the library.

- Why the flags for the letters 'n' and 'c' are used for distress.
- Fog signals used in international waters.
- The different type of day shapes that can be used and what they mean.
- The different flag signals for the letters of the alphabet and what they mean.

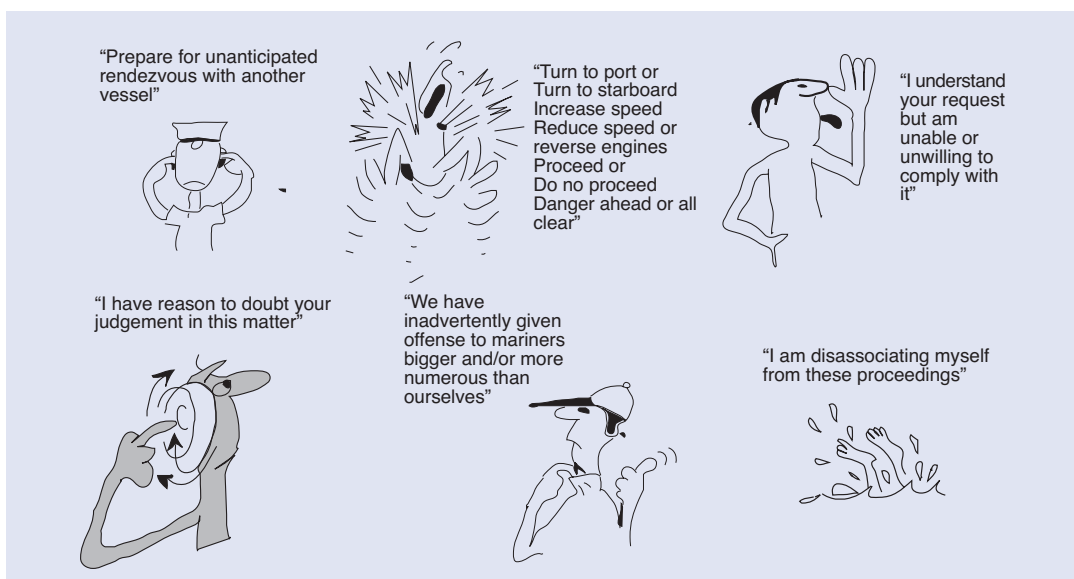

Figure 40.1 Non-standard hand signals for use by coxswain on bow to communicate with skipper in wheelhouse while manoeuvring in close quarters prior to docking



# WORKSHEET 13 MAYDAY RESEARCH QUESTIONS

---

1. List equipment considered by the yachtsman as vital for safety during offshore passages.

---

---

---

---

---

---

---

---

2. 27 MHz Radio is most used by which marine groups?

---

---

---

---

3. How is the EPIRB activated and deployed?

---

---

---

---

4. Why are EPIRBs still activated when vessels have sent distress messages by marine radio?

---

---

---

5. What other distress signals are commonly used by mariners in trouble?

---

---

---

6. Why should abandoning ship be a last resort?

---

---

---

7. What are some of the features built into inflatable life rafts?

---

---

---

8. List the commentator's key survival tips on a life raft.

---

---

---

9. What is the function of the local user terminals at Albany and Bundaberg? (Remember the video is out of date)

---

---

---

---

10. What resources can the Maritime Rescue Coordination Centre call upon in emergency rescue situations?

---

---

---

---

---

# WORKSHEET 14 MAYDAY

*Sea Witch VL 1234* has just sailed onto Maclean Reef and is holed badly.

1. Use the speech bubble A below to write out your Mayday call.

**A**



Reef

Wet Paper

2. The life raft is being deployed, the EPIRB is activated and attached to the life raft. The crew then abandon ship into the life raft. Describe how an EPIRB should be activated.

---

---

---

---

---

---

---

---

3. You are the skipper of *Wet Paper I* and hear a MAYDAY call from *Sea Witch*. It appears no other vessel has responded. You are 10 nautical miles from Maclean Reef. Use speech bubble B to write out your response.

**B**

Wet Paper 1

Reef

Wet Paper

4. The crew are rescued and the danger has passed. Use speech bubble C to write out how to finish the distress situation.

**C**

Reef

Wet Paper 1

Wet Paper

# WORKSHEET 15 PAN PAN

*Sea Witch VL 1234* has just hit the submerged log and lost its propeller. She is drifting south towards Maclean Reef.

1. Use the speech bubble below to write out a PAN PAN signal.

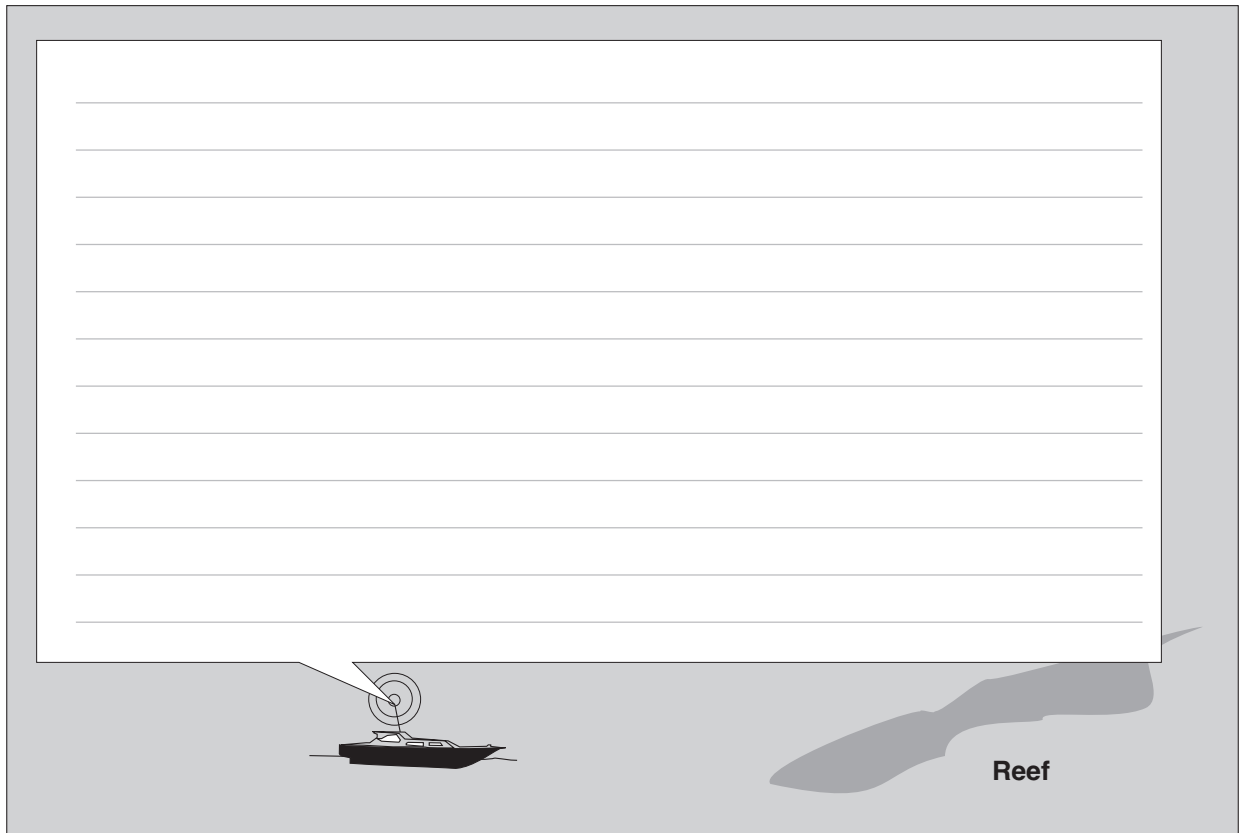

2. Give two other examples of when you would send a PAN PAN message.

---

---

---

---

3. Why are PAN PAN messages important?

---

---

---

---

---

---

4. Complete the following sentences by adding the correct word.

A Pan Pan message is a ..... signal concerning the safety of a .....

or ..... or the ..... of a person.

# WORKSHEET 16 SAY-CURE-E-TAY

*Sea Witch VL 1234* has just sighted a submerged log in the main shipping channel in Hypothetical Bay, 10 miles out from Lynch River.

1. Use the speech bubble below to write out a SAY-CURE-E-TAY signal.

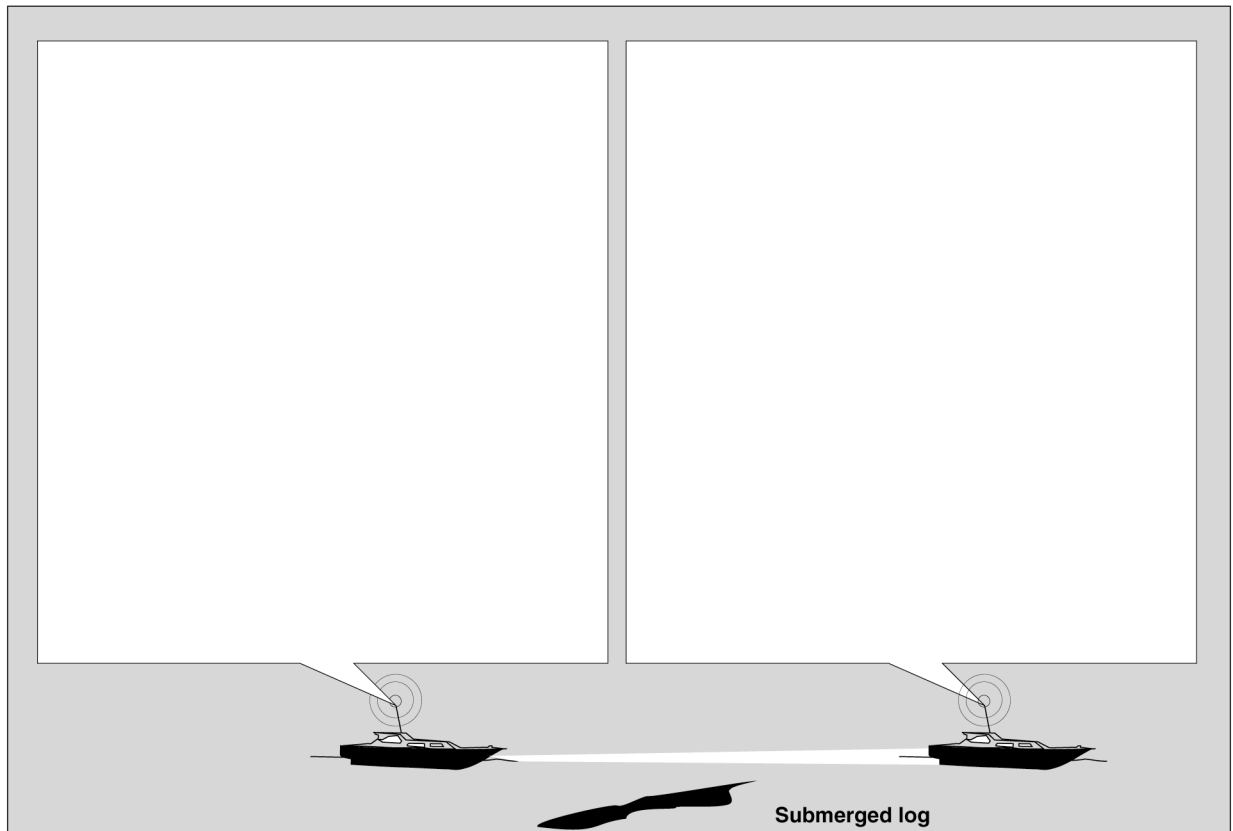

2. Give two other examples of when you would send a SAY-CURE-E-TAY message.

---

---

---

---

---

---

3. Why are SAY-CURE-E-TAY messages important?

---

---

---

---

---

4. Complete the sentence:

A SAY-CURE-E-TAY message is a ..... signal.

# WORKSHEET 17 FIND-A-WORD PUZZLE

S A F E T Y Y L V J A K X R A D I O R R G O U T A  
Y F R E Q U E N C Y H Y C A L L S I G N J S S X N  
W A R N I N G S F S R O M E O A F B L O G U R R T  
L F J A L A R M S I G N A L J U U I W J J M W I E  
S K Y W A V E S I M Z B A T T E R Y Z G Z K U L N  
E Z D I G I T A L K B M O D U L A T I O N C Y Z N  
B M F L Y L P B F T R A N S M I T T E R O T H O A  
J V E S V U D A U R G E N C Y B Y A L E I T Q J B  
W Y G J Y P A N P A N C E Y O E E L S C U U J I Q  
H E R T Z U E P I R B G U U I J A C G E D U A L S  
D I S T R E S S V Y Z B E A C O N B Q I U O V E R  
Y E O G M D S S E M E R G E N C Y G X V V N U A J  
L J H X B D X L X S P U A A L V H F P E T B Z V S  
P K A R V L B T R A N S C E I V E R V R D H O S E  
W D M V D P R O P A G A T I O N J S E C U R I T E  
N T R K N O T S M I C R O P H O N E X R P V E U L  
L T P S C Q M A Y D A Y E W M T X P D C U S M C O  
U K Z C W G Q D M P H O N E T I C Y D S C O I G N  
K J A E O O J S Q U E L C H I N M A R S A T E K C  
C L A R I F E R Q I K A E X J J X C H A N N E L E

## Word list

RADIO  
ROMEO  
BEACON  
ANTENNA  
FREQUENCY  
MODULATION  
PHONETIC  
LOG  
KNOTS  
GMDSS

VHF  
PANPAN  
EMERGENCY  
RECEIVER  
SKYWAVES  
SQUELCH  
SEELONCE  
URGENCY  
OUT  
INMARSAT

DIGITAL  
MAYDAY  
HERTZ  
TRANSMITTER  
OVER  
CHANNEL  
BATTERY  
SAFETY  
ALARMSIGNAL  
CALLSIGN

SECURITE  
EPIRB  
TRANSCEIVER  
MICROPHONE  
PROPAGATION  
CLARIFER  
DISTRESS  
CQ  
DSC  
WARNINGS

# SECTION 10 KEEPING YOUR RADIO WORKING

There are six main areas that can cause problems with keeping your radio working in good order. These are flat batteries, faulty earths, incorrect power supplies, faulty antennas, faulty microphones and blown fuses.

## 1. Flat batteries

### The battery

The battery supplies power for the radio on most small boats and consists of a solid case made of hard plastic containing lead electrodes and filled with an electrolyte (Figure 47.1).

In many cases this is sulphuric acid however some batteries are filled with a gel to produce a similar effect. The chemical reaction between the acid and the lead produces an electric current which serves as the power supply. Batteries are an essential part of the electrical system of a larger boat with a key to start the motor.

### Number of batteries

The number of batteries depends on the power needed to operate the boat. If the batteries are connected in series, the voltage can be increased. If connected in parallel, the number of amp hours they supply can be increased (Figure 47.2). Only use marine batteries because they run critical electrical systems such as the engine starting, radio, lighting and navigation instruments.

### Testing a battery

Testing is designed to tell us things we want to know about individual cells and batteries (Figure 47.1). Some typical questions you can ask the person who tests your battery are:

- Is it fully charged? How much charge is left in the battery? How long will it last?
- Does it meet the manufacturer's specification? Has there been any deterioration in performance since it was new?
- Does it generate interference or electrical noise? Is it affected by interference or electrical noise?

The answers are not always straightforward and places like Battery World can help you solve these issues.

### Battery care

- Use a good quality marine battery - check it at regular intervals and charge it when necessary.
- Batteries should always be secured in brackets and properly ventilated - be careful not to spill acid on yourself
- Keep terminals, cables and casing clean. Grease cables regularly. Terminals and connections need to be tight and secure.
- Battery cells need to be topped up with distilled water and checked with a hydrometer.
- Batteries should never be overcharged. They should be charged at a rate as set down by the manufacturer. Turn the power off before removing charging leads to prevent an explosion.

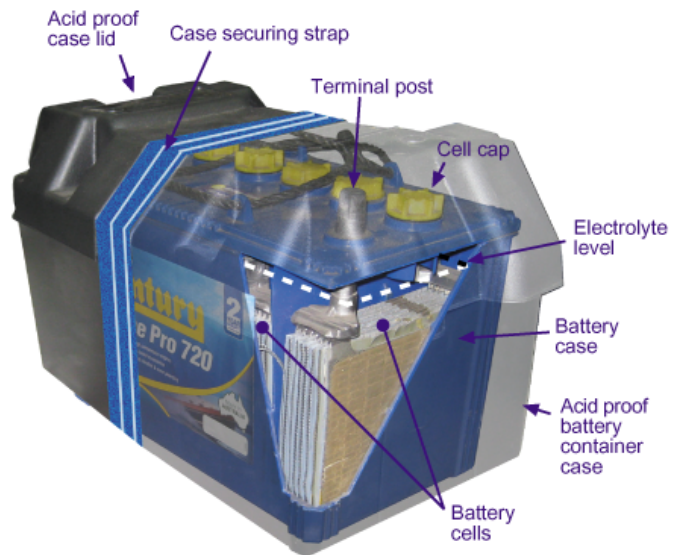

Figure 47.1 Parts of a battery

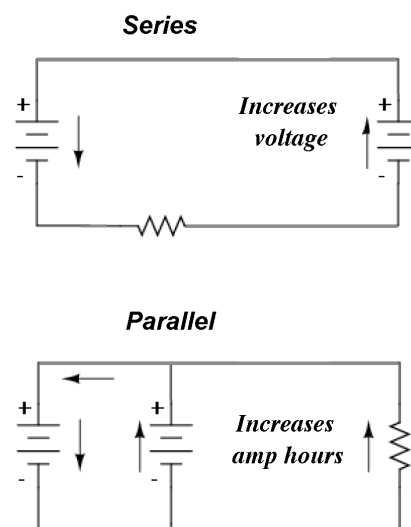

Figure 47.2 Series and parallel circuits

Wet Paper

### Safety and hazards

If you check or carry a battery you MUST wear protective clothing and acid resistant gloves.

- Battery acid is very poisonous and never wipe your eyes if you spill the acid on your gloves (for acid spills, irrigate all areas with lots of water).
- Coming loose during your trip - make sure the battery is securely tied down and the battery box is ventilated to stop build up of flammable gases.
- Salt water in the bilge and battery acids can make for an explosive mixture.
- Electrical hazards can include shorting with the hull, frayed wiring and globes that short out. If using shore power make sure there is proper grounding and circuit breakers to protect you from being electrocuted. Boats need marine electrical grade wiring as household copper wire will corrode in days making it useless.
- Dampness, dirt, and acid on the battery case can create a circuit between the terminals that will drain the battery.

## New batteries

In modern gel and deep cycle batteries the manufacturer's recommendations must be followed to the letter

### Reference

[www.batteryworld.com.au](http://www.batteryworld.com.au)

## 2. Faulty earths

All MF/HF radios must have an electrical earth connection to the water surrounding the vessel. If this connection becomes faulty, an operator may experience a sharp burning sensation from metallic parts of the transceiver during transmission.

## 3. Incorrect power supply

The radio is totally dependent on the power supply. There are five main points to know about lead acid batteries.

### Check the charge level

This is checked by a hydrometer which is a floating glass tube with markings that show the density of the liquid it is floating in. Hydrometers are used for battery acid, marine aquaria and home-brew kits.

A reading of 1150 is considered flat whereas a reading of 1250 is considered charged. All the cells in the battery should have a similar specific gravity. The specific gravity of the electrolyte varies with the amount of charge in the battery and should not be checked after 'topping up' the electrolyte.

Measuring the on-load terminal voltage (ie, when the battery is supplying current), will also provide an indication of the amount of charge in a battery. For a 12 volt battery the on-load terminal voltage should not fall significantly below 11.4 volts when transmitting.

### Top up the electrolyte

When topping up the electrolyte (the liquid inside the battery) you should always use distilled or demineralised water.

The electrolyte should be kept about halfway between the top of the plates and the filler hole.

### Charging

Batteries are normally charged by an alternator in a boat.

However a battery may become discharged if the boat is not running on a regular basis.

A battery charger and jumper leads as shown in Figure 48.2 are used to charge a flat battery. Most automotive mechanics recommend short periods of discharging followed by a total recharge as the best way to use a battery. However a battery will only take about 10 total discharges after which time it should be replaced.

Batteries can be damaged by long periods of heavy charging and advice from qualified automotive mechanics should be sought.

### Rules when using jumper leads

When using jumper leads with batteries, take care to put the clamps on the correct terminals.

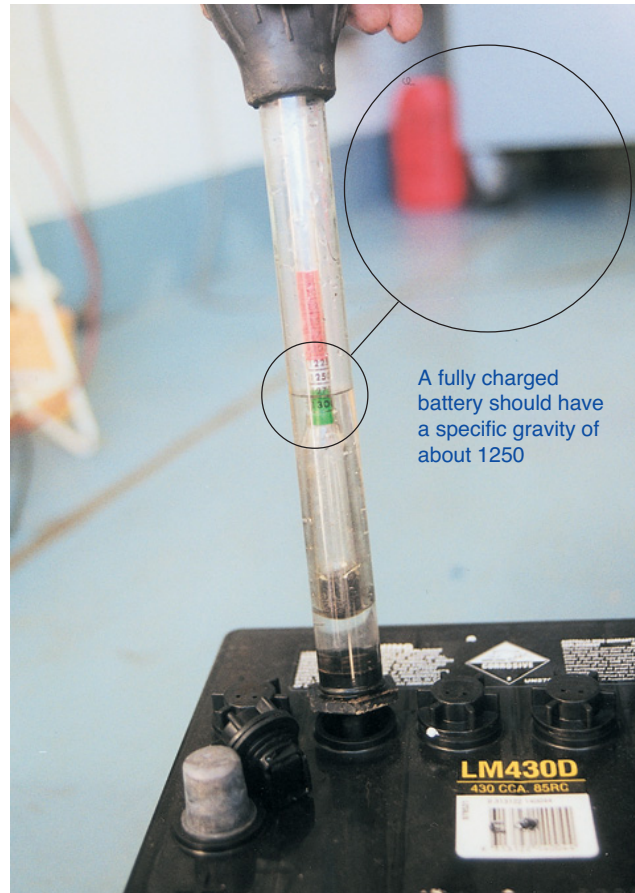

Figure 48.1 A hydrometer is used to check the electrolyte

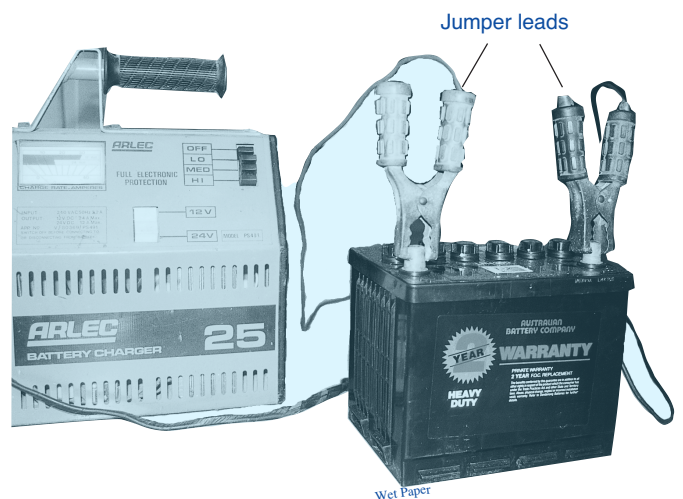

Figure 48.2 Batteries should be charged by qualified auto mechanics



Positive to positive (red to red) and negative to negative (black to black). If you connect red to black for sure you will blow up some electronics somewhere.

Check with your local garage for further details of ways to charge specific types of batteries.

### Hazards

Batteries give out hydrogen during charging and should be well ventilated to avoid an explosive gas-air mixture.

The electrolyte (the liquid) in the battery cells is sulphuric acid.

This acid is corrosive and care must be taken with this liquid that it does not come in contact with your skin and especially not in contact with your eyes.

A green-white powder can form around the terminals of the battery as shown in Figure 49.1.

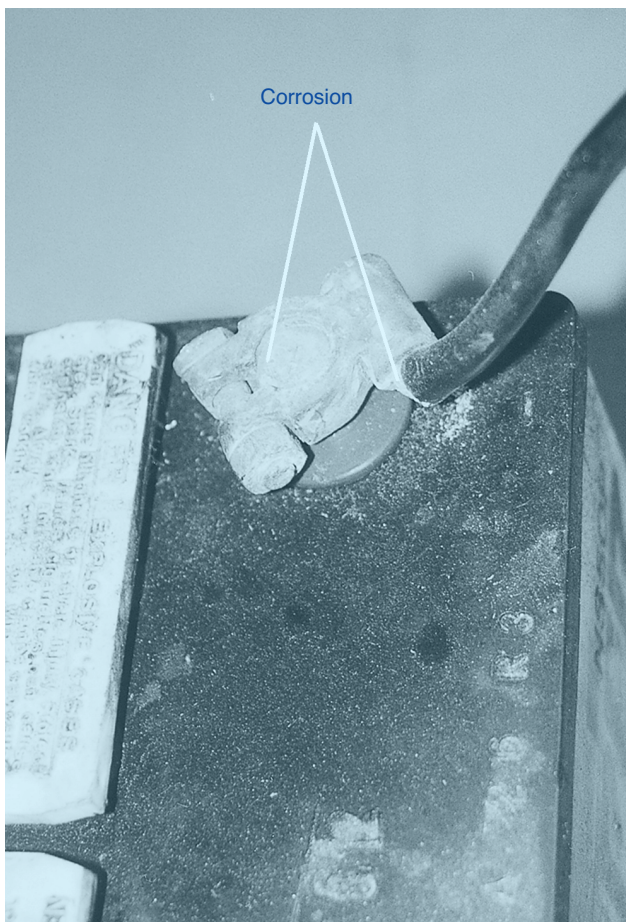

Figure 49.1 Battery terminals should be kept clean and free of corrosion

This powder is a form of corrosion and may affect the battery's ability to supply current. The terminals should be kept clean and covered with grease.

### Location

Batteries should be located to ensure they are

- protected from the elements
- accessible for maintenance
- close to transceiver
- as high as practicable.

## 4. Faulty antennas

If the antenna was broken by wind or water, there would be no signals coming in or going out. If the antenna had a bad connection, you would see the output needle flickering, there would be crackle from the speaker and incoming signals would be cutting in and out.

A salt build up on the antenna also results in poor reception and transmission.

Regular wiping of the antenna reduces this problem. Using the incorrect antenna affects performance so it is important to match the antenna with the radio and have it tuned properly.

## 5. Faulty microphones

If the microphone is faulty we can expect the receiver to work perfectly but transmission to be poor or non-existent. Usually a spare microphone can be plugged in.

## 6. Blown fuses

A blown fuse is easy to diagnose because there will be no transmission or reception and no dial lights.

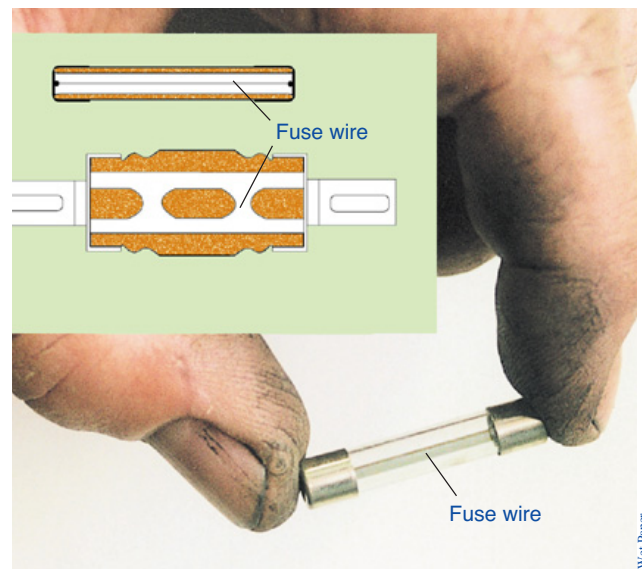

Figure 49.2 Types of fuse

### Amp ratings

An amp rating is the rated current of the fuse. This is the maximum current that will be allowed to flow through the fuse before it blows.

This will be written in either Amps (A) or milliamps (mA) on the side of the fuse.

### Reference

[www.batteryworld.com.au](http://www.batteryworld.com.au)

## Connecting a 27 MHz marine transceiver to a battery

Three major components must be considered when connecting a marine radio to a power source:

1. the wiring harness (including earthing)
2. fuses
3. antennas.

### Wiring harness

1. Inspect the wiring supplied with the marine transceiver. Note the black lead, the earth lead and the red positive lead as shown in Figure 50.1.
2. The red positive lead must have a fuse holder connected close to the point where the positive lead will join the power source.
3. Do not connect the harness to battery at this stage.

### Fuses

1. Manufacturers will specify the amp rating of the fuse to be used in conjunction with the positive lead. This fuse is designed to represent an electrical weak spot in the wiring harness. Should a fault develop in the power source, the fine wired fuse will blow to prevent damage to the circuitry within the transceiver.
2. Inspect the fuse holder and carefully dismantle it (usually spring loaded) to inspect the amp rating of the fuse and to check its integrity.

Return the fuse to the wiring harness when you are satisfied the fine wire is intact.

3. Do not connect harness to battery at this stage.

### Antenna

1. Inspect the connection plug leading from the antenna. Note that the cable plug appears to have a central and outer core. This is referred to as co-axial cable.
2. Plugs are usually designed to be gently pushed into a receiving socket within the transceiver itself and then pulled into place by tightening a threaded sleeve over the cable and onto the socket. Seat the plug, but be careful not to cross thread the sleeve as you tighten the fitting.

### Power source

(For negative earth systems)

1. Inspect antenna connection security. Do not turn power on without antenna connected.
2. Check security of wiring harness and fuse.
3. Attach red, positive harness lead to the positive (+) terminal of the 12-volt power source.
4. Attach the black earth lead to the negative (-).

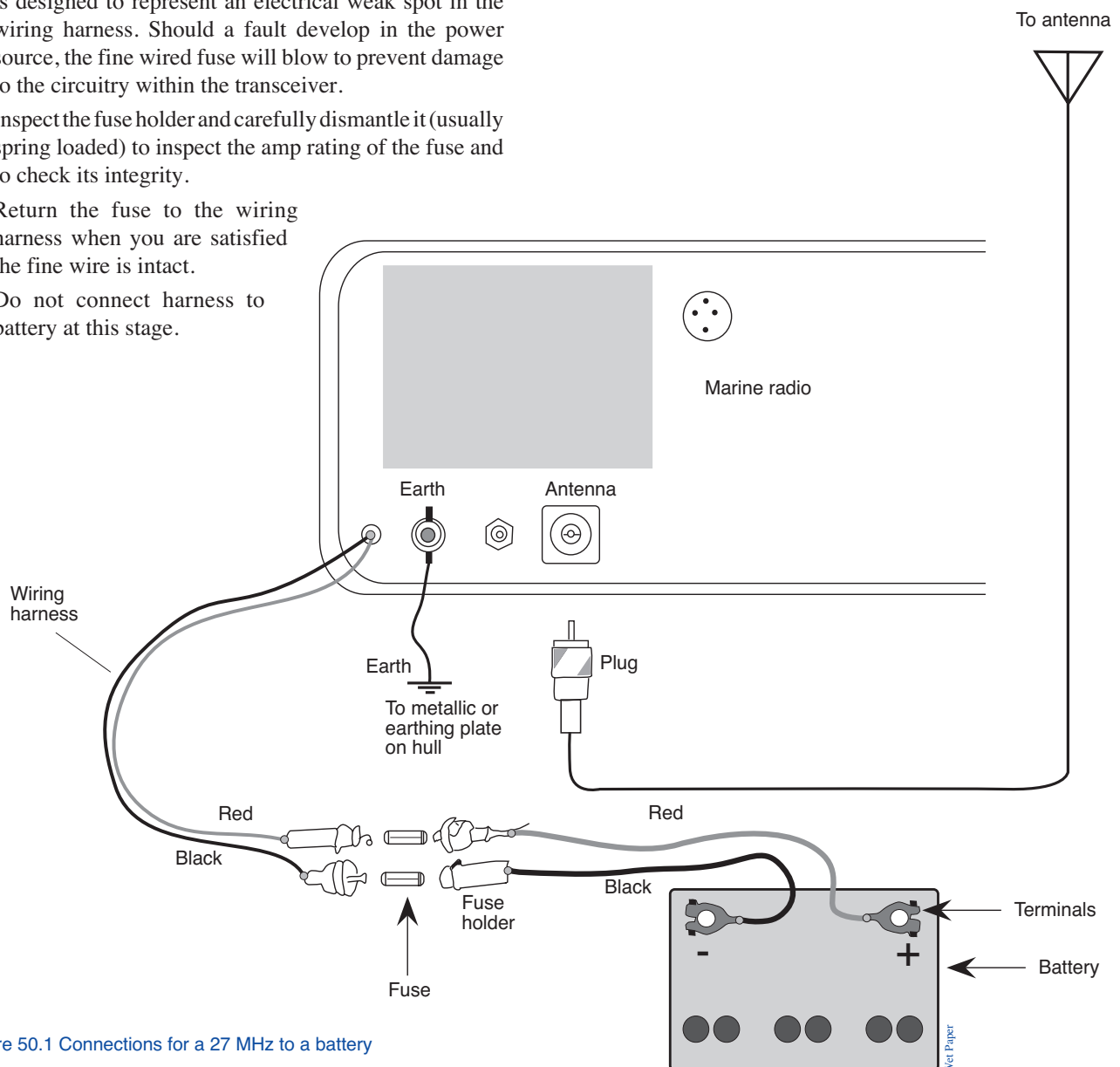

Figure 50.1 Connections for a 27 MHz to a battery

# WORKSHEET 18 CONNECTING A 27MHZ TRANSCIVER

---

Based on an original exercise by Mark Rickard and Kelvin Rogers, Benowa State High School

1. What are the three things to identify prior to connection?  
\_\_\_\_\_  
\_\_\_\_\_
2. The wiring harness has three leads. What are they and what are their respective colours?  
\_\_\_\_\_  
\_\_\_\_\_
3. What is a fuse?  
\_\_\_\_\_
4. What is an amp rating on a fuse?  
\_\_\_\_\_  
\_\_\_\_\_
5. What does the term spring loaded mean and where may one come across it?  
\_\_\_\_\_  
\_\_\_\_\_
6. The connection plug to the antenna has two parts. What are they?  
\_\_\_\_\_
7. How should the plug be connected to the radio?  
\_\_\_\_\_  
\_\_\_\_\_
8. Why don't you connect the battery until the antenna is connected?  
\_\_\_\_\_  
\_\_\_\_\_
9. There is a rule for connecting 12 volt systems involving colours. What is it?  
\_\_\_\_\_  
\_\_\_\_\_  
\_\_\_\_\_
10. What terminal is the red harness lead connected to?  
\_\_\_\_\_
11. What terminal is the black earth connected?  
\_\_\_\_\_
12. When can you switch on the power?  
\_\_\_\_\_  
\_\_\_\_\_
13. What is the electrolyte that is found in a battery and why then does care have to be taken when handling batteries?  
\_\_\_\_\_  
\_\_\_\_\_
14. What effect does a build-up of the white-green powder on the terminals of the lead acid battery have on the functioning of the battery?  
\_\_\_\_\_  
\_\_\_\_\_

# WORKSHEET 19 INSTALLATION AND FAULTS

Complete the following table:

Component	Where component is located	Care that needs to be taken
Antenna and fittings	<hr/> <hr/> <hr/>	<hr/> <hr/> <hr/>
Microphone	<hr/> <hr/> <hr/>	<hr/> <hr/> <hr/>
Radio earth	<hr/> <hr/> <hr/>	<hr/> <hr/> <hr/>
Fuse box	<hr/> <hr/> <hr/>	<hr/> <hr/> <hr/>
Battery acid level	<hr/> <hr/> <hr/>	<hr/> <hr/> <hr/>
Battery terminals	<hr/> <hr/> <hr/>	<hr/> <hr/> <hr/>
Battery charging	<hr/> <hr/> <hr/>	<hr/> <hr/> <hr/>

# WORKSHEET 20 THE BATTERY

1. Complete the missing parts of the battery in the diagram below. Then label the important components.

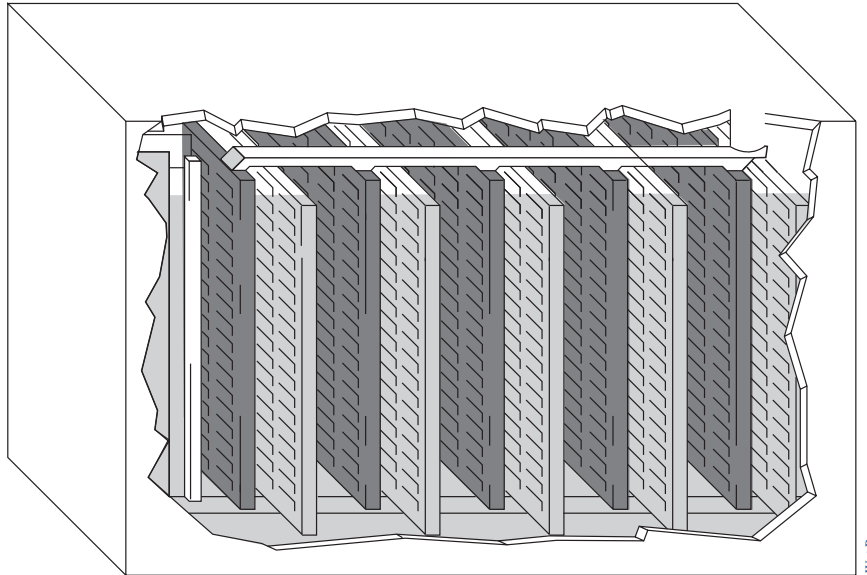

2. When you charge a battery, what precautions should you take?

---

---

---

3. When you carry a battery what precautions should you take?

---

---

---

4. What voltages are marine batteries?

5. What is the rule when using jumper leads with batteries?

---

---

---

6. Modern motor cars have electronic computer systems. What precautions need to be taken when using modern electronics and jumper leads?

7. Complete the following sentence (see page 47)

Batteries are an essential part of the \_\_\_\_\_ system of a larger boat with a \_\_\_\_\_ used to crank the engine.

8. What are two simple rules to follow when using a battery?

---

---

---

9. What is a hydrometer and how is it used to test a battery?

---

---

---

# WORKSHEET 21 MAKE A REFERENCE CARD

## Project

Often in the heat of the moment, you can forget simple things such as your call sign, a letter in the phonetic alphabet, the name of your boat, your home phone number etc.

1. Make up a small sticker like the one shown in Figure 54.1, writing down all information from the phonetic alphabet to use as a quick reference.
2. Redraw and colour in the radio silence circle as well to help remind you of the silence periods.
3. Research other information that may prove useful e.g. home, doctor, police, ambulance, hospital, rescue association phone numbers.

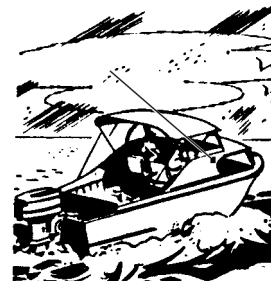

**Local call sign for air sea rescue**

---

**Call sign of my boat**

---

**My boat's name**

---

**Other details**

---

---

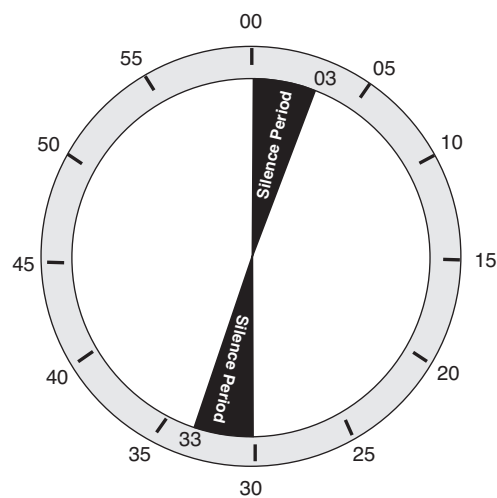

Figure 54.1 Sample quick reference sticker

# SECTION 11 MARINE RESCUE AND PUBLIC CORRESPONDENCE

Mostly, when the term station has been used in this booklet it has been referring to radio equipment found on a boat. Radio equipment located on shore is loosely referred to as a coast station. There are three types of stations that are found on land:

- maritime communication stations
- State and Northern Territory HF (coast radio) stations
- limited coast stations.

## Maritime Communication Stations

Two maritime communication stations are operated by TVNZ(A) at Charleville (Qld) and Wiluna (WA). They provide the following services to vessels:

- search and rescue operations in conjunction with the RCC
- automated voice transmissions of weather forecasts and warnings from the Bureau of Meteorology
- continuous automated watch on HF DSC frequencies.

The MMSI of both stations is 005030001 and their call sign is 'RCC Australia'.

They do not provide aural monitoring of any frequencies or DSC monitoring of the MF frequency 2187.5 kHz.

## State and Northern Territory HF (coast radio) stations

A system of nine stations is being developed by state and territory authorities to provide 24 hour aural monitoring of HF distress, urgency safety and calling channels. These are being located at Cairns, Gladstone, Sydney, Melbourne, Hobart, Adelaide, Perth, Port Headland and Darwin.

Each is identified by the call sign 'Coast Radio' followed by the location.

Navigation warning information is broadcast on 8176 kHz (commencing three minutes prior to the hour) and a listening watch is maintained on 4125, 6215 and 8291 kHz.

## Limited Coast Stations

Limited coast stations are established to carry out a particular function within the following areas:

- commercial fishing industry
- other commercial vessels and marinas
- port or harbour operations
- boating and fishing clubs
- volunteer marine rescue organisations.



Figure 55.1 A limited coast station

Hours of operation may vary between stations. Their function is essentially to monitor local distress, urgency and safety frequencies, broadcast weather and other safety information and record the movements of vessels.

State and Territory authorities have also arranged limited VHF coverage of coastal waters, generally in conjunction with Port Authorities and/or volunteer groups.

Queensland – Fraser Island to Tweed Coast and adjacent to Townsville

New South Wales – Newcastle to Nowra

Victoria – adjacent to Port Phillip and Western Port Bay

Western Australia – adjacent to Perth

Northern Territory – adjacent to Darwin.

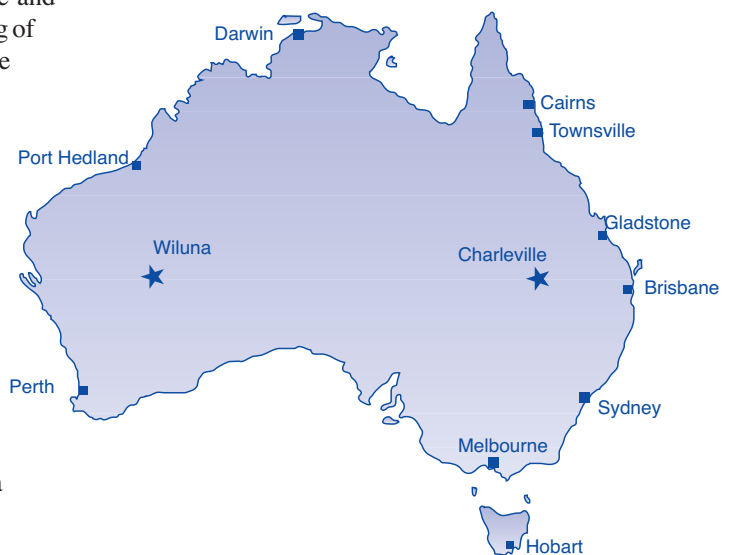

Figure 55.2 Two maritime communication stations are operated by TVNZ(A) at Charleville (Qld) and Wiluna (WA). 24 hour aural monitoring of HF distress, urgency safety and calling channels are being located at Cairns, Gladstone, Sydney, Melbourne, Hobart, Adelaide, Perth, Port Headland and Darwin.

Wet Paper

## Radiotelephone calls

By using facilities provided by Telstra, marine radios operating in the VHF band can be used to connect with the national telephone network. This allows persons on board ships to make telephone calls to anywhere in Australia or overseas, and telephone subscribers ashore to make calls to persons at sea. Charges apply for the service.

Depending on the model of transceiver used by the ship, connection to the telephone system can be direct-dial or coast station operator connected. A similar service exists for persons ashore wishing to contact a vessel at sea.

Radiotelephone calls on VHF marine radios are generally known as Seaphone calls.

Limited coast stations such as those operated by marine rescue organisations are not permitted to accept radiotelephone calls to or from ships.

An automated version of the Seaphone service known as Auto Seaphone covers virtually the entire eastern seaboard of mainland Australia. Other major population centres in Tasmania, South Australia, Western Australia and the Northern Territory are also served.

Provided a suitably equipped vessel is within range of one of many unmanned land aerials, the ship can directly access the telephone network and dial the required number via a keypad on the radio or the microphone. The interconnect is made via a computer at the coast or land station and no operator connection is required.

The Auto Seaphone service also provides semi automatic connection of shore to ship telephone calls. In these cases, it is necessary for the ship to periodically interrogate the shore based computer system to determine whether there are any outstanding calls for it.

The keypad entry 999 may be used in the Auto Seaphone service to alert other stations to an emergency situation. The 999 signal will be recognised by the shore computer system and cause an alarm to ring at a coast station. The coast station operator will be informed of the details of the vessel and an emergency announcement will be made to all ships.



Figure 56.2 A seaphone



Figure 56.1 Radiotelephone calls keep friends at home up to date with your movements at sea

## Mobile phones

In many areas near major coastal towns and cities, mobile phone coverage allows communication from sea to land.

In cases where this occurs, it would be advised to obtain the telephone number of the local volunteer marine rescue association (VMR) and use this as a backup in case of an emergency.



Figure 56.3 In areas with good coverage mobile phones can provide a valuable backup



## Marine satellite communication

The international maritime satellite organisation (**Inmarsat**) operates a system of satellites providing a range of telecommunications services to vessels.

Operating at super high frequencies, (UHF — see Figure 5.2 - parts of the radio spectrum, page 5), the Inmarsat system provides a full range of communications including telex, telephone, facsimile and computer data. It also provides a dedicated distress alerting system whereby a ship in distress is automatically connected to a maritime rescue co-ordination centre.

The Inmarsat system employs four operational satellites in a geostationary orbit above the equator, over the Atlantic, Indian and Pacific Oceans as shown in Figure 57.2.

In combination the satellites provide continuous high quality communications to virtually the entire Earth's surface. Backup satellites are ready for use if necessary.

The geostationary orbits of the satellites means that each moves at exactly the same rate as the Earth's own rotation and therefore remains in the same relative position to any point on the Earth. Powered by solar energy, each satellite acts as a transmitting and receiving station, relaying messages between stations located on the Earth's surface.



Figure 57.1 Satellite antenna ship earth station

Geostationary satellites remain over a fixed position of the Earth's surface.

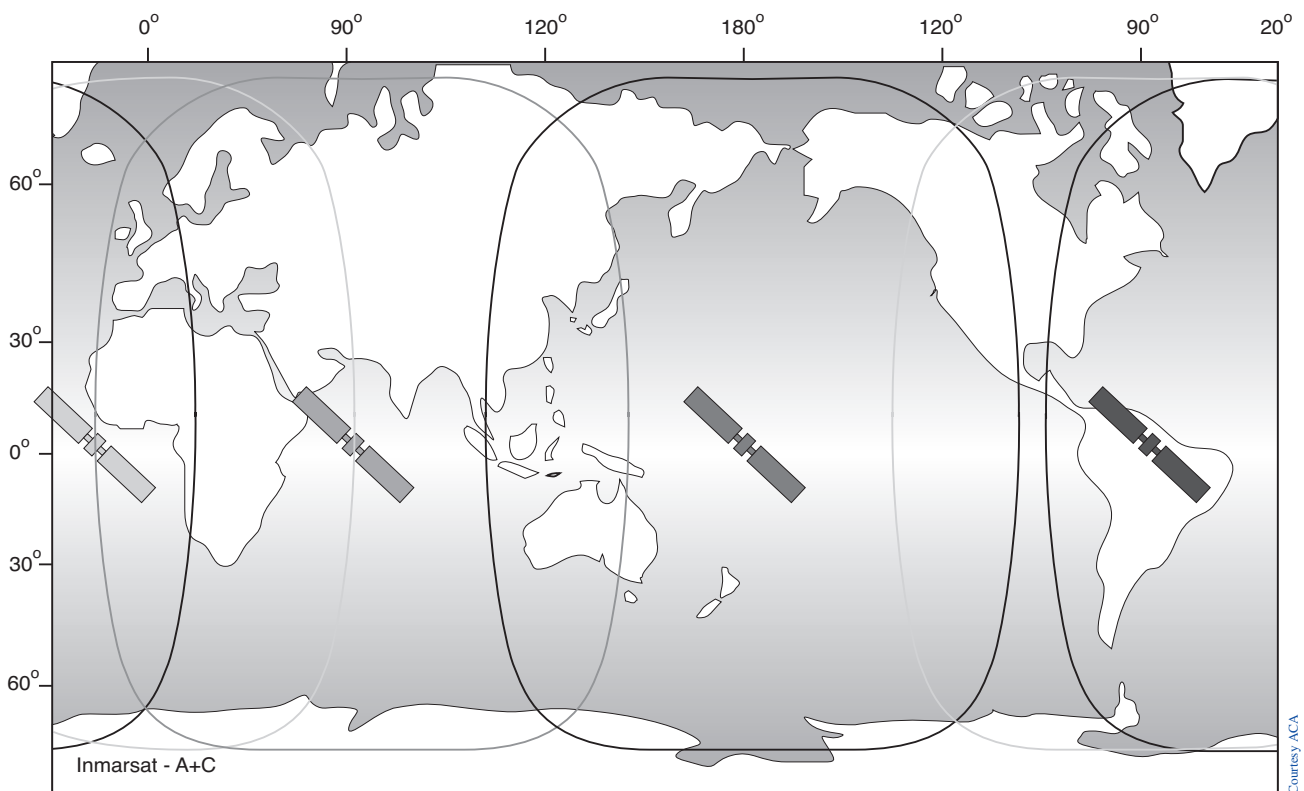

Figure 57.2 Each satellite has its own area of coverage (known as a footprint) which is that part of the Earth's surface within which an antenna can view the satellite.

## Search and rescue

Australia's area of responsibility for marine search and rescue (SAR) covers one-ninth of the world's surface, more than 20 million square nautical miles.

Under the national search and rescue plan, searching for missing pleasure craft and fishing vessels is the responsibility of State or Northern Territory SAR authorities (i.e. the police).

However, if an incident reaches a point where police resources are over extended, the Commonwealth's rescue co-ordination centre (RCC) can be asked to take over co-ordination.

Contacting relatives of missing persons and organising port and beach searches remain police duties. In searches where the MRCC is the coordinating body, the responsibility for keeping relatives informed of progress is undertaken by the MRCC management team.

### Search and rescue operations

The major function of the centre is to coordinate the search and rescue of mariners in distress in Australia's area of responsibility.

Each year the centre deals with hundreds of marine incidents. It conducts searches, answers requests for medical evacuations, traces overdue yachts and handles other less dramatic incidents such as investigating unexplained flare sightings. When searches are coordinated by State police, the centre is often asked to provide expert advice and information.

When the centre takes over a search, the senior co-ordinator assumes total control of the operation. The first task is to decide what to search for, a disabled yacht, wreckage, a life raft etc. A description of the vessel, skippers experience and likely course of action he or she may take is some of the information required. The second task is to calculate the search area. To do this, the co-ordinator draws on information about the movement of objects in the water, tidal flows and weather conditions and combines use of computer systems with years of practical experience of the search and rescue team.

## The Australian ship reporting system (AUSREP)

The AUSREP system is a ship reporting system which monitors the movement of many vessels undertaking voyages anywhere within Australia's search and rescue areas.

Before departure, a sailing plan is lodged with the rescue coordination centre in Canberra. Position reports are then sent every 24 hours or when changes are made to the original sailing plan; and on arrival a final report is made. This information is used to track the vessel along its entire route.

The Australian Maritime Safety Authority advised that small vessel operators using AUSREP should be aware that it is a positive system. They advise that once a sailing plan is lodged, failure to make daily reports or a final report will result in the rescue coordination centre making preliminary checks to ascertain the vessel's safety.

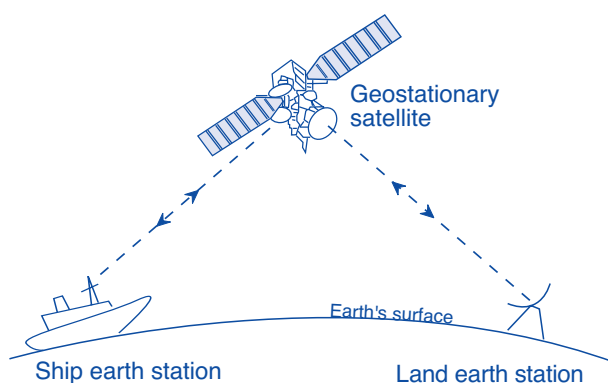

Figure 58.1 Communication via satellite  
Wet Paper

If after these checks are completed, the vessel is still unreported or overdue, a further assessment will be made to determine the next course of action.

Small vessels may participate in AUSREP. No charges are made, however certain conditions must be met including:

- the voyage must be more than twenty-four hours between different ports, or greater than 200 nautical miles
- a satellite compatible EPIRB must be carried
- a current 'Small Craft Particulars Form' must be lodged with the authorities in Canberra
- approved GMDSS (Inmarsat C and/or HF DSC) equipment must be carried to enable the vessel to report to AMSA throughout the voyage.

### The maritime rescue and co-ordination centre

This centre is located in Canberra and operates around the clock and is staffed by ex-mariners with wide experience in maritime and search and rescue operations.

Its computer controlled communications system enables contact with a wide variety of organisations including the police in all States, the defence forces, international maritime and SAR organisations, merchant ships, fishing cooperatives, harbour and marine authorities, yacht clubs and volunteer marine rescue groups. The MRCC may contact aviation authorities for search purposes.

### Rescue coordination centre Australia

Search and rescue (SAR) uses the latest technology including satellites to assist distressed mariners.

The rescue coordination centre (RCC) employs these aids to establish the most likely area in which to find distressed mariners.



# WORKSHEET 23 REVIEW QUESTIONS

---

1. What does the word 'skip' mean?  
\_\_\_\_\_  
\_\_\_\_\_
2. What are the three major parts of a marine radio equipment system?  
\_\_\_\_\_  
\_\_\_\_\_  
\_\_\_\_\_
3. What is the function of the transmitter and what type of radio waves does it produce? Once these waves are produced how are they modulated?  
\_\_\_\_\_  
\_\_\_\_\_
4. What is the function of the receiver and how are radio skywaves reconverted to sound?  
\_\_\_\_\_
5. What does the antenna in a marine radio equipment system do?  
\_\_\_\_\_  
\_\_\_\_\_
6. Name three types of marine radio.  
\_\_\_\_\_  
\_\_\_\_\_  
\_\_\_\_\_
7. What is an EPIRB and what does it do?  
\_\_\_\_\_  
\_\_\_\_\_
8. Name five ways small boat operators can use 27 MHz radio transceivers.  
\_\_\_\_\_  
\_\_\_\_\_  
\_\_\_\_\_
9. What channel is a 27MHz set usually left on and why?  
\_\_\_\_\_  
\_\_\_\_\_
10. What channel is a VHF set normally left on and why?  
\_\_\_\_\_  
\_\_\_\_\_
11. When is a radio operators certificate of proficiency required?  
\_\_\_\_\_  
\_\_\_\_\_
12. Draw a diagram to show how a geostationary satellite receives and sends radio signals.  
\_\_\_\_\_  
\_\_\_\_\_  
\_\_\_\_\_  
\_\_\_\_\_

13. How are EPIRBs located using satellites?

---

---

14. Give an example of a radio communication using normal traffic procedures.

---

---

---

15. What is a radio silence period and draw a diagram to illustrate what it means.

---

---

---

---

---

16. What does the word 'securite' mean?

---

17. Give an example of a SECURITE message.

---

18. What is the term for an urgency signal and when should it be used?

---

---

19. Give an example of how an urgency signal is used.

---

---

20. What is the term used for a distress signal and when should it be used?

---

---

21. Give an example of a MAYDAY call.

---

---

---

22. You become involved in a MAYDAY situation and you cannot provide assistance. What do you do?

---

---

23. How can an antenna become faulty?

---

---

24. What is a blown fuse and how can you tell it has occurred?

---

---

25. List main points about marine batteries that affect good radio transmission.

---

---

---

---

# WORKSHEET 24 THEORY TEST

---

Your vessel's name is *Wet Paper* and you are positioned 30 nautical miles south-east of Cape Morteon. Your vessel is an 8.5 metre cabin cruiser with a red hull and a white superstructure. You have four persons on board with you and you're heading in a northerly direction. Your radio call sign is VLM 1234 and you have a VHF transceiver with digital selective calling and a 27 MHz radio. You have a life raft, EPIRB and all other safety equipment required by law.

Outline the message you, as skipper, would send in the following situations:

1. You have just sighted a large red ship container floating just below the surface at your present position. You consider this a hazard to shipping as it is in the main shipping channel.

---

---

---

---

2. Your vessel has suffered engine failure and you have been unable to repair the fault. You are now drifting but you are not in any immediate danger. Please use a digital selective calling alert as part of your message.

---

---

---

---

3. You have just received a distress message from the vessel *Seahunter*, call sign VNN884 on the 27 MHz set. The message indicates this vessel is sinking and is positioned 20 nautical miles south-east of Cape Morteon. You are in a position to provide assistance and believe you can reach the stricken vessel in 45 minutes.

---

---

---

---

4. You have just received a message from the vessel *Cool Charm* which is on fire after an explosion in the engine compartment. The fire is uncontrollable and they are abandoning ship into a life raft. Their position 50 nautical miles north-east of Cape Morteon. Because of limited fuel and distance from the vessel you are unable to help. You continue to monitor the distress frequency and record that no other station has responded to the message within 10 minutes.

---

---

---

---

5. Your vessel has just had a collision with another submerged shipping container and is taking in water fast through a large hole on the port side. The pumps have been unable to keep up with the intake of water and you predict you will only be able to stay afloat for 10 minutes. Use your 27 MHz set to send the appropriate message.

---

---

---

---

---

---

---

---

# WORKSHEET 25 REVISION TEST

---

- In an emergency at sea a vital link for being rescued or obtaining assistance is a radio. A radio wave was first produced by
  - Isaac Newton
  - Ernest Rutherford
  - Heinrich Hertz
  - Albert Einstein
- Carrier waves may alter to carry speech information by altering the size of the wave. This is known as
  - amplitude modulation
  - radio telephony
  - Morse code
  - tremometer imbalance
- Which of the following radio types would normally be used by international yachts whilst on long distance voyages?
  - VHF
  - MF/HF
  - 27 MHz
  - AM
- Which band is not reflected by the ionosphere and consequently is by ground wave only? It is effective for short ranges only and is a 'line of sight' band.
  - VHF
  - MF/HF
  - AM radio
  - 27 MHz
- Which of the following statements concerning radio waves is true?
  - Sky waves travel much further than ground waves before they lose their energy.
  - Sky waves lose their energy faster than ground waves.
  - Ground waves are more effective for long distance broadcasting.
  - Radio wave energy can radiate from the receiver as x-rays.
- Some radio sets can be connected into the land telephone system and hence the name seaphone service. A radio operator's certificate of proficiency is required to operate these sets. The sets are
  - 27 MHz
  - S.S.B.
  - VHF
  - HF
- Annoying background noise and interference can be eliminated by adjusting the
  - clarifier
  - sqelch control
  - noise limiter
  - RF gain
- An EPIRB is
  - a marine communication system
  - a small battery operated floating transmitter
  - an emergency voice transmitter and receiver
  - an emergency positional indicating and responding buoy
- The effect of loud static interference can be minimised by the use of which control? Unfortunately, the control knob can also have the effect of desensitising the receiver to wanted signals. The control is
  - clarifier
  - sqelch control
  - noise limiter
  - RF gain
- What word should you say if your transmission is ended but you expect a response from the other party?
  - out
  - over
  - romeo
  - securite
- Sometimes when radio reception is poor it may be necessary to spell words or use the phonetic alphabet. The word used for 'D' is
  - December
  - danna
  - data
  - delta
- Safety signals are used when a station wants to pass information concerning safety such as navigation warnings or weather warnings and are identified by the word/s
  - Seelonce feenee
  - Pan Pan
  - Securite
  - Hello all stations
- An urgency signal indicates that the station sending the message has a very urgent message to transmit concerning the safety of a ship or person. Urgency messages are sent on all distress frequencies and are identified by the words
  - Securite
  - Pan Pan
  - Mayday
  - Help
- Before using a radio, the operator should always glance at a watch or clock to see if it is an official radio silence period. These periods are:
  - three minutes before the hour
  - three minutes beginning every hour and every half hour
  - five minutes after every hour
  - not required for uses of 27 MHz radio
- On transmitting a message, we see the output needle flickering and there is a crackle from the speaker. Incoming signals are cutting in and out. The most probable fault would be
  - a blown fuse
  - the antenna has been broken
  - the antenna had a bad connection
  - the battery is low on charge



16. A transmitter emits radio waves of a frequency of 27.00 MHz. What is the wave length of these waves in air if the speed of sound is 340 m/sec? Use formula  $v = f \lambda$ :  $v$  = speed of sound  $f$  = frequency  $\lambda$  = wavelength

---



---



---

(3 marks)

17. Refers to Figure 64.1 below. You also need to know that a ten decibel (1 bel) sound delivers ten times as much energy as a zero decibel sound, while a sound of 20 decibels (2 bel) delivers 100 times as much energy.

a. For a person to hear a sound of 50 Hz what intensity will it have to be?

b. What is the range of frequency the human voice can produce?

---



---

c. What is the lowest frequency a musical instrument can make?

d. At what intensity of sound will 5000 Hz reach its threshold of pain?

e. How much more energy of sound is needed for you to hear a 100 Hz sound as compared to a 50 Hz sound?

f. What is the highest frequency of sound that a human can hear and at what level of intensity does it have to be?

g. What is the lowest intensity note a musical instrument can make and still be heard? (10 marks)

---



---



---



---



---



---



---



---

Figure 64.1 Graph for question 2

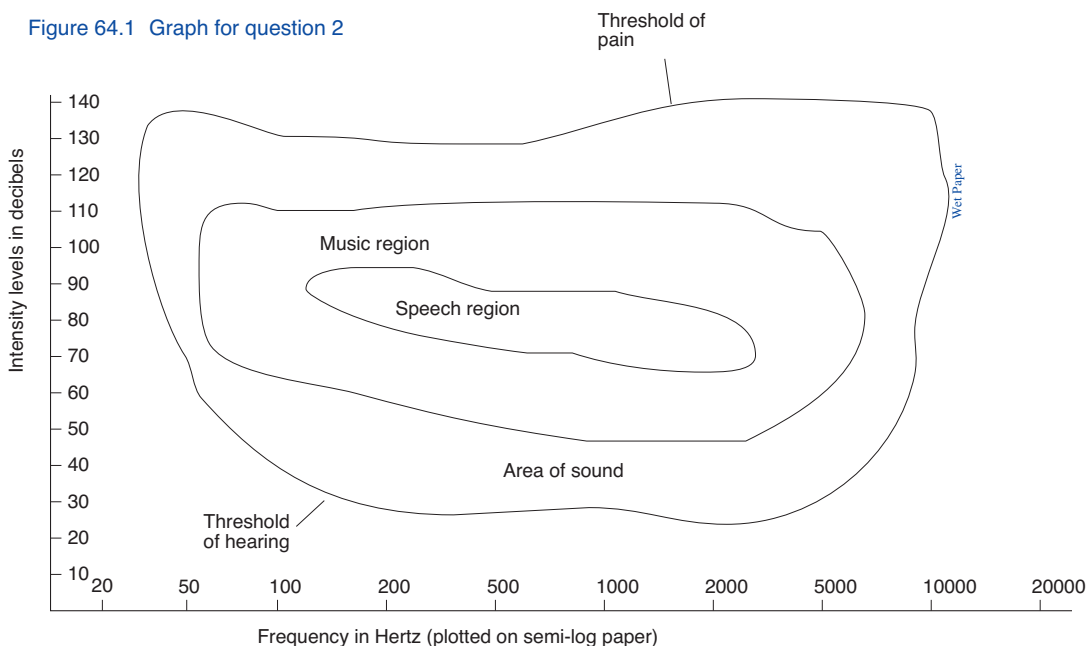





**ISBN**

**978-1-86283-140-7**